



Product Specification Sheet

EK-FC5870

EAN / Part #: 3831109835067

Copper Plexi

Copper Acetal

Nickel Plexi

Nickel Acetal

Summary:

- Featuring a unique, modern look copper design High performance VGA water block for Radeon HD5870 reference design series graphic cards.
- EK FC series water blocks cover all chips on graphic cards that require cooling if overclocked.
- An extreme high flow path design and unique increased cooling surface over GPU keeps all your graphic cards components cool even at highest graphical loads and over clock.
- Blocks base is made of SE CU electrolytic copper.
- High quality CNC manufacturing.
- Leak tested to 2 bar pressure (30psi).
- Safe, noob-proof mounting system with Standoffs.

Key Features:

- Real high flow internal design gives minimum flow restriction which allows lowest possible temperatures, not only at VGA water block, but also in the entire water-cooling system.
- Cools GPU, VREG, I/O CHIPS and MEMORY modules.
- Multiple barb/fitting position allows 4 different fitting configurations. Allows maximum flexibility for water cooling system setup also in CF.
- Reduces temperatures up to 50°C or more at maximum load.
- Much cooler components, allow maximum possible overclocking.

Technical data:

- dimensions of copper base: 165 x 119,5 x 8mm
- dimensions of acrylic top: 165 x 119,5 x 8mm
- threads: 4 x G 1/4
- fittings: optional, not enclosed
- neto weight: 700g
- bruto weight: 780g

Packing list:

- 1 x Water block
- 2 x EK-Plug G 1/4
- 2 x EK-G 1/4 Spacer with o-ring
- Mounting mechanism with 10 x POM Acetal standoffs
- Thermal pads

Do not forget other EK products for your water cooling system:



blocks



radiators



pumps



resevoirs



accessories

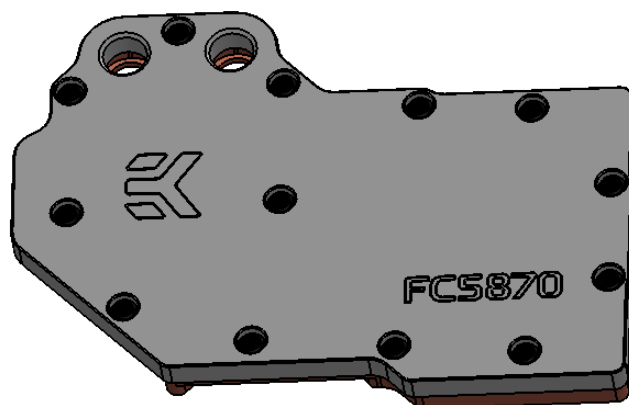
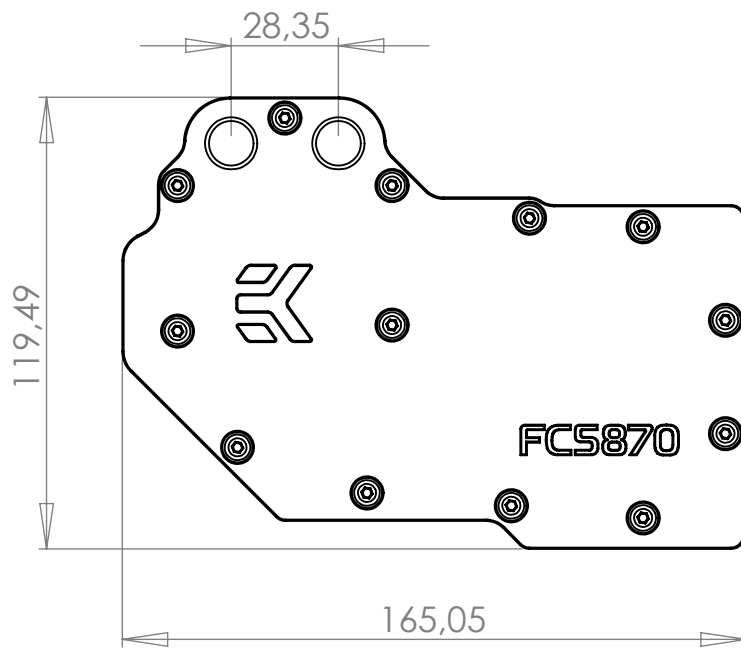

IMPORTANT DISCLOSURE: Drawing is copyrighted and property of EKWB d.o.o. company. Drawing is supplied only for easier compatibility recognition by user and can not be used for any other intention.

PRODUCT NAME: EK-FC5870

Scale: 1:2

Sheet format A4

Sheet 1 of 1