

EK-Quantum Vector² Strix/TUF RTX 4090 D-RGB

GPU WATER BLOCK

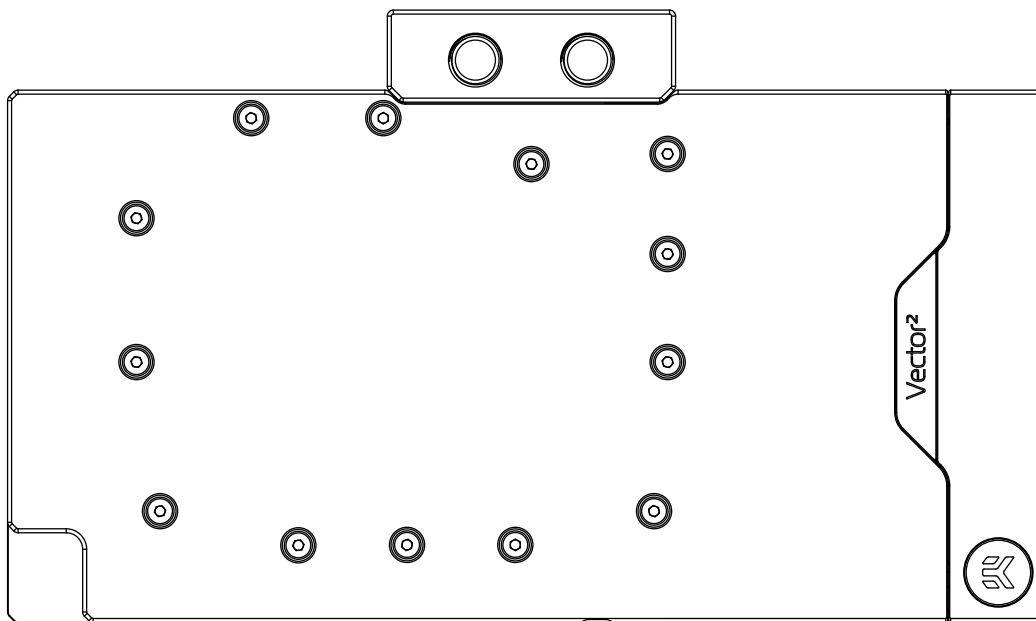

Please note the installation of the product is intended to be undertaken by an adequately trained and experienced person. You are installing the product at your own risk. If you are not properly trained or experienced or feel unsure about the installation procedure, please refrain from installing the product yourself and contact our tech support for assistance. We disclaim our liability for any damages to the product as well as incidental, consequential, or indirect damages incurred due to improper or inappropriate installation.

Before you start using this product, please follow these basic guidelines:

Carefully read the manual before beginning with the installation process.

Remove your graphics card from the computer for the safest mounting process to prevent any possible damage to your GPU or its circuit board (PCB).

The EK Fittings require only a small amount of force to screw them firmly in place since the liquid seal is ensured by the rubber O-ring gaskets.

The use of corrosion-inhibiting coolants is always recommended for liquid cooling systems and mandatory for nickel-plated water blocks!

Do not use pure distilled water!



For best results, EK recommends the use of EK-CryoFuel coolants! To reach optimal performance, make sure to thoroughly bleed the air out of your water block!

TABLE OF CONTENTS

BOX CONTENTS	4
BOX CONTENTS – Rev 2	5
WATER BLOCK DIMENSIONS	6
DIFFERENCE BETWEEN Rev 1 AND Rev 2 COLDPLATE	7
TECHNICAL SPECIFICATIONS AND WATER BLOCK PARTS	8
NICKEL PLEXI	8
WHITE EDITION	9
NICKEL ACETAL	10
PREPARING THE GRAPHICS CARD	11
REMOVING THE STOCK COOLER	11
ASUS TUF GAMING GEFORCE RTX 4090	11
PREPARING THE WATER BLOCK FOR INSTALLATION	13
CUTTING AND PLACING THERMAL PADS - Rev 1	14
CUTTING AND PLACING THERMAL PADS - Rev 2	15
APPLYING THERMAL COMPOUND	16
ATTACHING THE WATER BLOCK (Option 1: GeForce RTX 4090 ROG Strix)	16
ATTACHING THE WATER BLOCK (Option 2: GeForce RTX 4090 TUF)	18
INSTALLING THE BACKPLATE - Rev 1	19
INSTALLING THE BACKPLATE - Rev 2	20
ATTACHING THE BACKPLATE	21
INSERTING THE GRAPHICS CARD INTO THE CHASSIS	22
FITTINGS AND TUBING	22
CONNECTING THE D-RGB LED STRIP	23
TESTING THE LOOP	23
WARRANTY	24
SUPPORT AND SERVICE	25
SOCIAL MEDIA	25

BOX CONTENTS

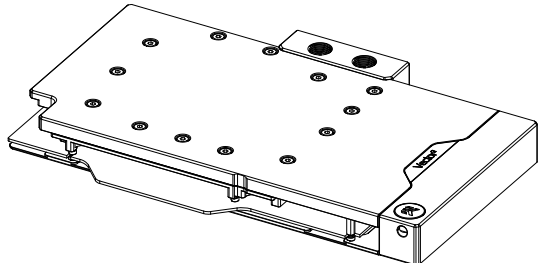
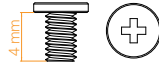
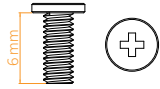
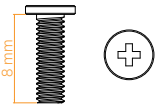
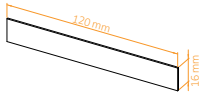
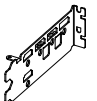
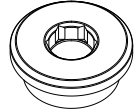
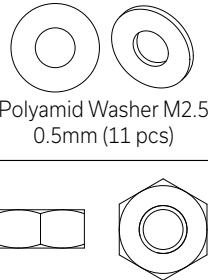
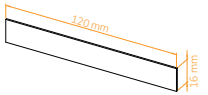
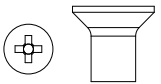
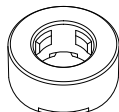
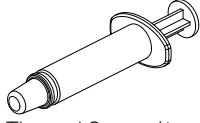
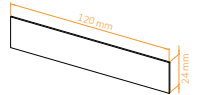

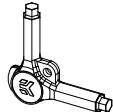



EAN: 105934

 <p>EK-Quantum Vector² Strix/TUF RTX 4090 D-RGB</p>	 <p>M2.5x4 AX1 Screw (11 pcs)</p>	 <p>M2.5x6 AX1 Screw (1 pc)</p>	 <p>M2.5x8 AX1 Screw (1 pc)</p>
 <p>Thermal Pad F 1.0 mm (6 pcs) (3830046996732)</p>	 <p>Replacement I/O Bracket (1 pc)</p>	 <p>Quantum Plug (2 pcs)</p>	 <p>Polyamid Washer M2.5 0.5mm (11 pcs) Nut M2.5 (2 pcs)</p>
 <p>Thermal Pad F 1.5 mm (2 pcs) (3830046996749)</p>	 <p>M3 x 6 DIN7991 Screw (2 pcs)</p>	 <p>Standoff Ø4.5/2.5 (1 pc)</p>	 <p>Thermal Grease (1 pc)</p>
 <p>Thermal Pad G 2.0 mm (4 pcs) (3830046996794)</p>	 <p>Allen Key 2 mm (1 pc)</p>	 <p>Allen Key 2.5 mm (1 pc)</p>	 <p>EK-Loop Multi Allen Key (1 pc)</p>

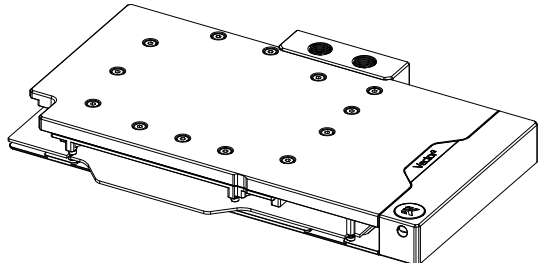
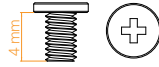
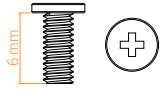
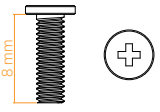
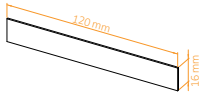
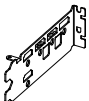
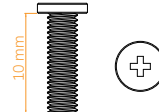
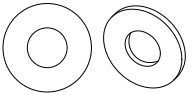
EAN: 106046

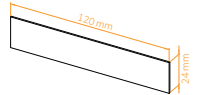
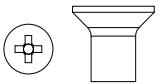
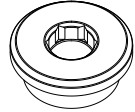
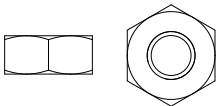
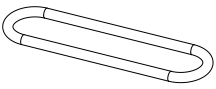
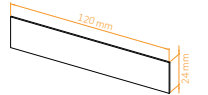
BOX CONTENTS – Rev 2

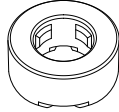
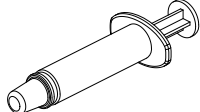
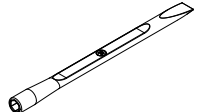
EAN: 105934

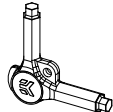
 <p>EK-Quantum Vector² Strix/TUF RTX 4090 D-RGB</p>	 <p>M2.5x4 AX1 Screw (11 pcs)</p>	 <p>M2.5x6 AX1 Screw (1 pc)</p>	 <p>M2.5x8 AX1 Screw (1 pc)</p>	
 <p>Thermal Pad F 1.0 mm (6 pcs) (3830046996732)</p>	 <p>Replacement I/O Bracket (1 pc)</p>	 <p>M3x10 AX1 Screw (1 pc)</p>	 <p>Polyamid Washer M2.5 0.5mm (11 pcs)</p>	 <p>Standoff M2.5-M3 x 6.6mm (1 pc)</p>
 <p>Thermal Pad G 1.0 mm (4 pcs) (3830046996770)</p>	 <p>M3 x 6 DIN7991 Screw (2 pcs)</p>	 <p>Quantum Plug (2 pcs)</p>	 <p>Nut M2.5 (2 pcs)</p>	 <p>Terminal OR 14x1 mm (2 pcs)</p>
 <p>Thermal Pad G 2.0 mm (2 pcs) (3830046996794)</p>	 <p>Allen Key 2 mm (1 pc)</p>	 <p>Standoff Ø4.5/2.5 (1 pc)</p>	 <p>Thermal Grease (1 pc)</p>	 <p>EK-Plug Out Spludger Tool (1 pc)</p>
	 <p>Allen Key 2.5 mm (1 pc)</p>	 <p>EK-Loop Multi Allen Key (1 pc)</p>	<p>EAN: 106046</p>	

WATER BLOCK DIMENSIONS

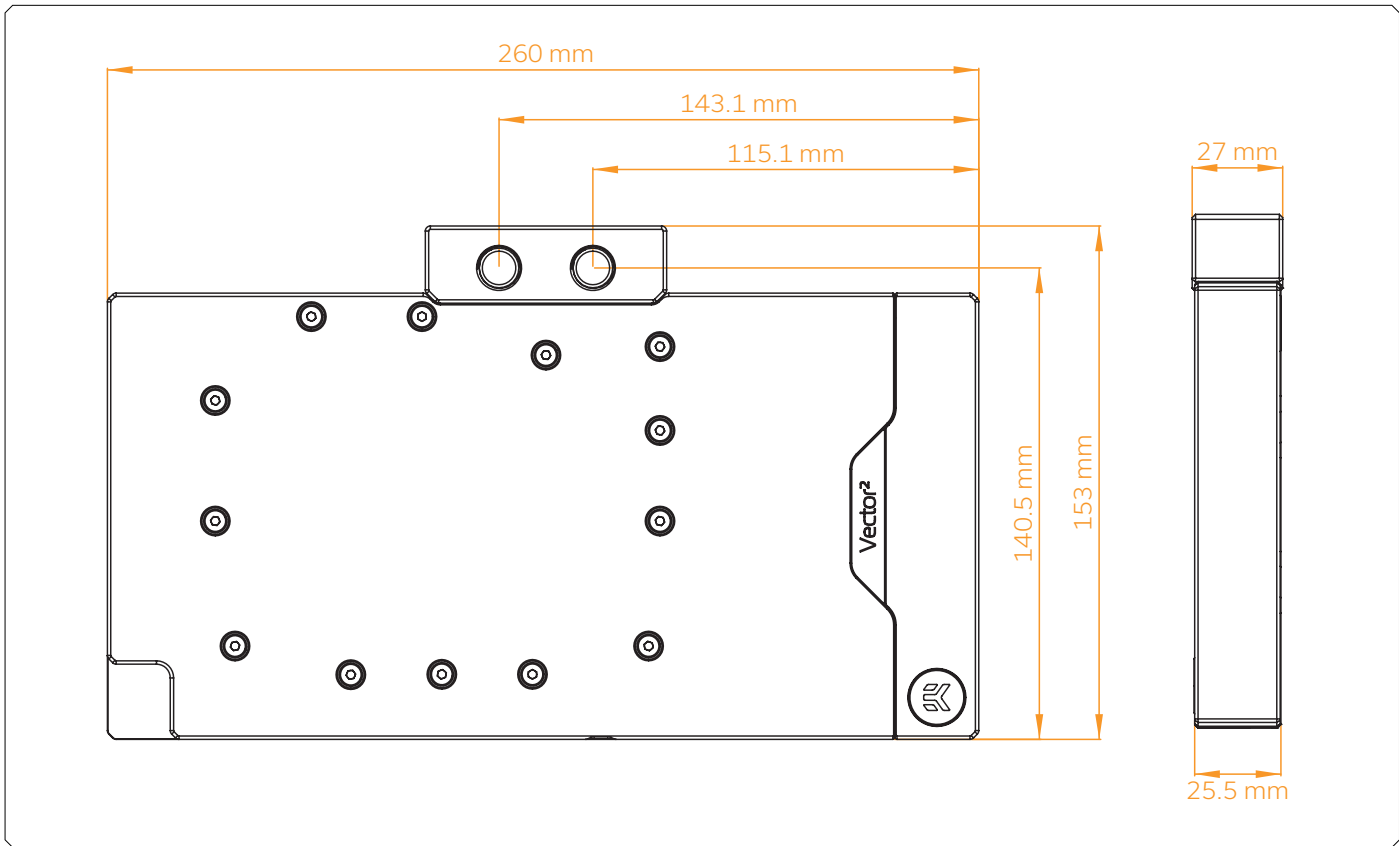

DIFFERENCE BETWEEN Rev 1 AND Rev 2 COLDPLATE

Before installing the water block, check the version of the coldplate.

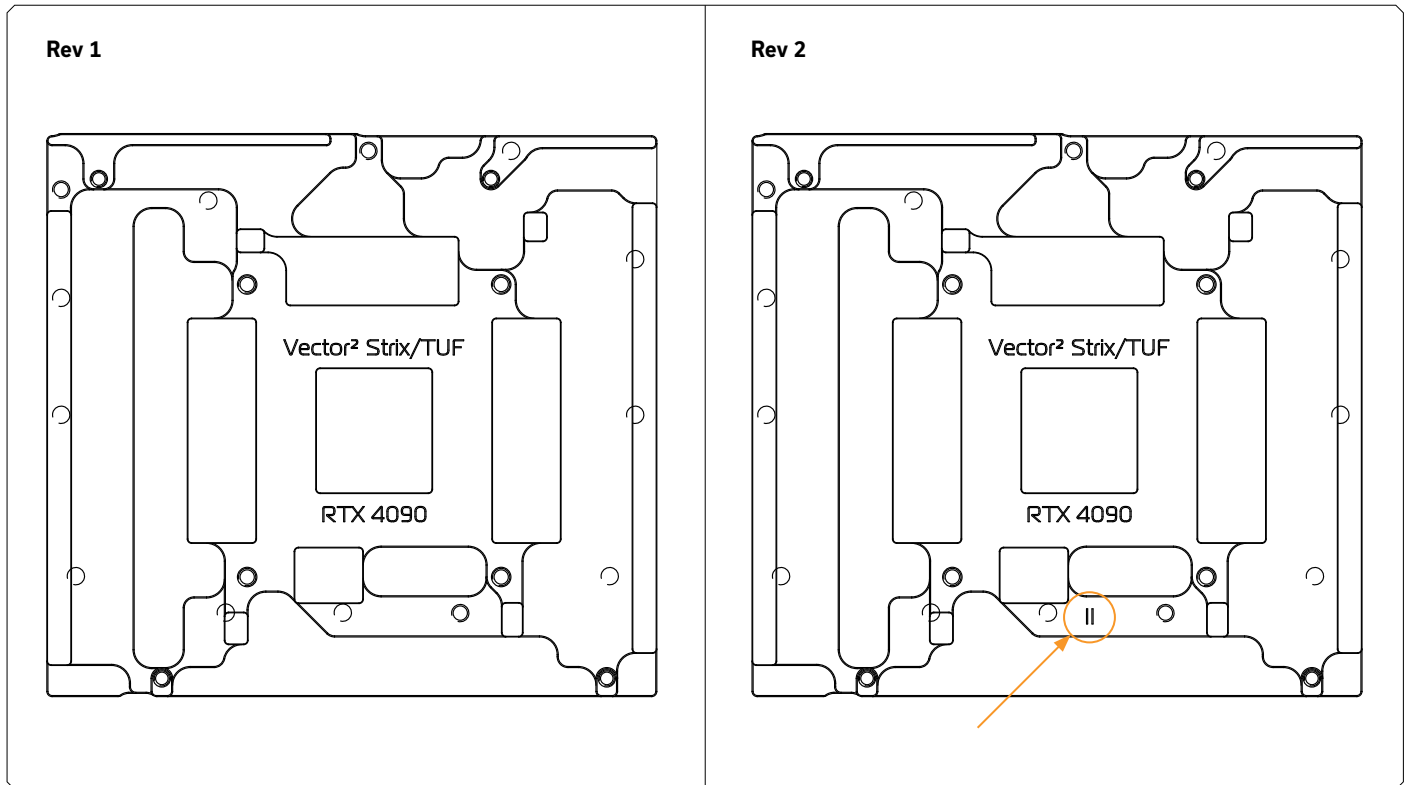

TECHNICAL SPECIFICATIONS AND WATER BLOCK PARTS

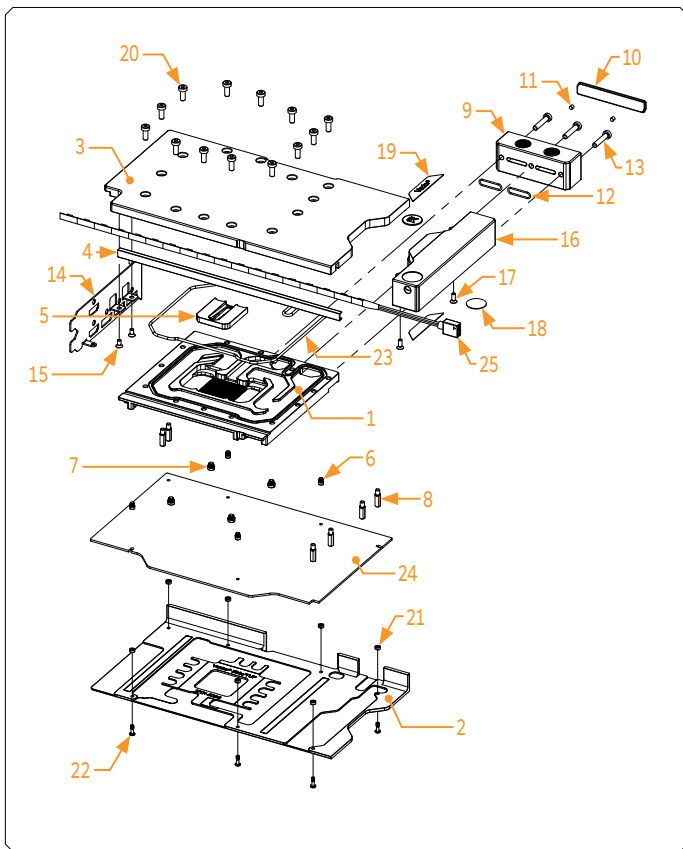

NICKEL PLEXI

- Dimensions: (L x H x W): 260 x 153 x 27 mm
- D-RGB LED count: 12
- D-RGB cable length: 50 cm
- D-RGB connector 3-pin 5V digital LED header

Position	EAN	Description	Quantity
1.1	105919	Coldplate (Ni) Rev 1	1
1.2	106227	Coldplate (Ni) Rev 2	1
2.1	105924	Backplate (Bl.elox) Rev 1	1
2.2	106211	Backplate (Bl.elox) Rev 2	1
3.1	105920	Top plate (Plexi) Rev 1	1
3.2	106228	Top plate (Plexi) Rev 2	1
4	105926	LED Cover (Nat. Elox)	1
5	103962	Plexi insert	1
6	103987	Standoff M3.5-M2.5 x 3 mm	4
7	103988	Standoff M4-M2.5 x 3 mm	4
8	103986	Standoff M3.5-M2.5 x 11.3 mm	6
9	105988	FC Terminal (Acetal)	1
10	103942	Terminal Badge	1
11	104216	Disc magnet 3 x 3	2
12	104106	Terminal OR - 14 x 1 mm	2
13	8311	Screw M4 x 20 DIN7984	3
14	105561	Replacement I/O Bracket (Black)	1
15	8472	Screw M3 x 6 DIN7991	2
16	103971	Stand out (Acetal)	1
17	8208	Screw M3 x 8 7991DIN	2
18	100663	EK - Badge	2
19	103964	Mylar sticker	2
20	9024	Screw M4 x 10 DIN7984	13
21	104188	Standoff 4.5/2.5 mm	7
22	104187	Screw M2.5 x 8 mm AX1	7
23	105932	Mian OR 150 x 2 mm	1
24	105935	PCB cardboard	1
25	101556	LED D-RGB strip 500/300 mm	1

WHITE EDITION

- Dimensions: (L x H x W): 260 x 153 x 27 mm
- D-RGB LED count: 12
- D-RGB cable length: 50 cm
- D-RGB connector 3-pin 5V digital LED header

Position	EAN	Description	Quantity
1.1	105919	Coldplate (Ni) Rev 1	1
1.2	106227	Coldplate (Ni) Rev 2	1
2	106731	Backplate (Nat.elox)	1
3.1	105920	Top plate (Plexi) Rev 1	1
3.2	106228	Top plate (Plexi) Rev 2	1
4	105926	LED Cover (Nat. Elox)	1
5	103962	Plexi insert	1
6	103987	Standoff M3.5-M2.5 x 3 mm	4
7	103988	Standoff M4-M2.5 x 3 mm	4
8	103986	Standoff M3.5-M2.5 x 11.3 mm	6
9	106644	FC Terminal (White acetal)	1
10	103942	Terminal Badge	1
11	104216	Disc magnet 3 x 3	2
12	104106	Terminal OR - 14 x 1 mm	2
13	8311	Screw M4 x 20 DIN7984	3
14	105561	Replacement I/O Bracket (Black)	1
15	8472	Screw M3 x 6 DIN7991	2
16	106645	Stand out (White acetal)	1
17	8208	Screw M3 x 8 7991DIN	2
18	100663	EK - Badge	2
19	106646	Mylar sticker (White)	2
20	9024	Screw M4 x 10 DIN7984	13
21	104188	Standoff 4.5/2.5 mm	7
22	104332	Screw M2.5 x 8 mm AX1 (Ni)	7
23	105932	Mian OR 150 x 2 mm	1
24	105935	PCB cardboard	1
25	101556	LED D-RGB strip 500/300 mm	1

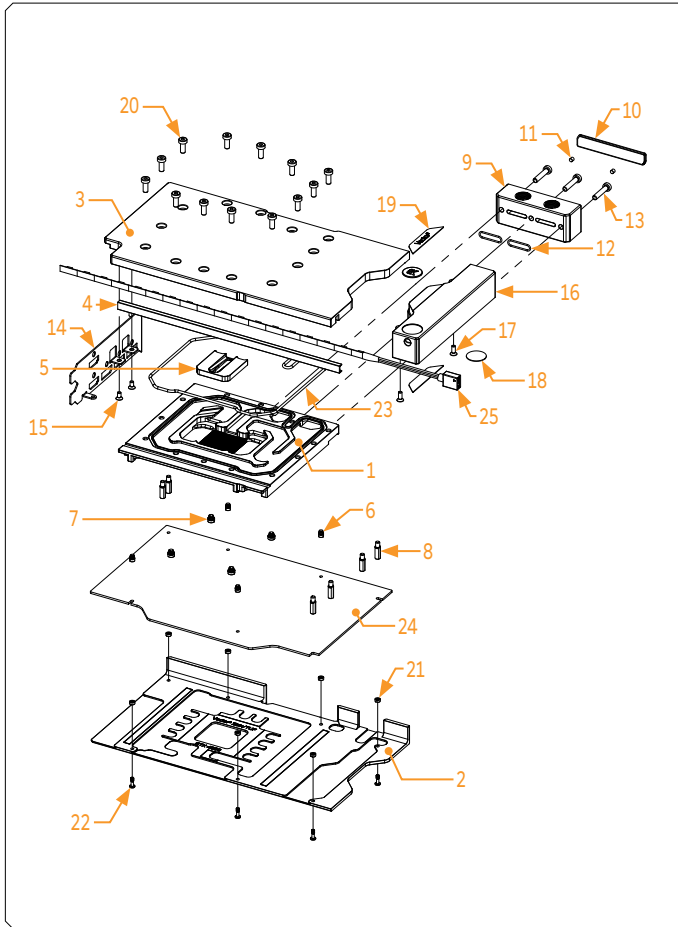

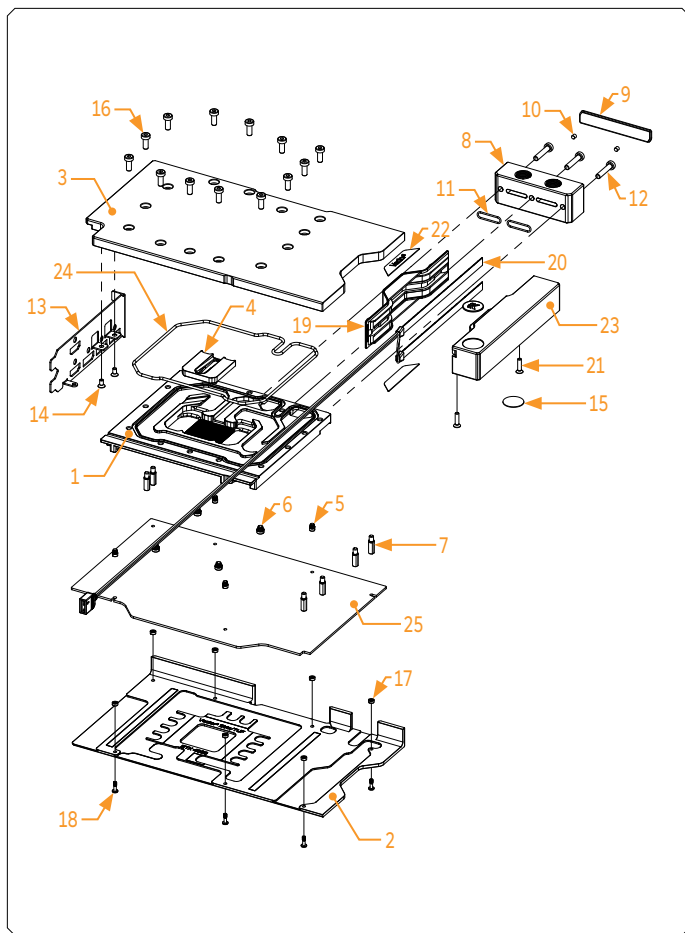

NICKEL ACETAL

- Dimensions: (L x H x W): 260 x 153 x 27 mm
- D-RGB LED count: 38
- D-RGB cable length: 50 cm
- D-RGB connector 3-pin 5V digital LED header

Position	EAN	Description	Quantity
1.1	105919	Coldplate (Ni) Rev 1	1
1.2	106227	Coldplate (Ni) Rev 2	1
2.1	105924	Backplate (Bl.elox) Rev 1	1
2.2	106211	Backplate (Bl.elox) Rev 2	1
3.1	105921	Top plate (Acetal) Rev 1	1
3.2	106230	Top plate (Acetal) Rev 2	1
4	103962	Plexi insert	1
5	103987	Standoff M3.5-M2.5 x 3 mm	4
6	103988	Standoff M4-M2.5 x 3 mm	4
7	103986	Standoff M3.5-M2.5 x 11.3 mm	6
8	105988	FC Terminal (Acetal)	1
9	103942	Terminal Badge	1
10	104216	Disc magnet 3 x 3	2
11	104106	Terminal OR -14 x 1 mm	2
12	8311	Screw M4 x 20 DIN7984	3
13	105561	Replacement I/O Bracket (Black)	1
14	8472	Screw M3 x 6 DIN7991	2
15	100663	EK - Badge	2
16	9024	Screw M4 x 10 DIN7984	13
17	104188	Standoff 4.5/2.5 mm	7
18	104187	Screw M2.5 x 8 mm AX1	7
19	103968	Light guide	1
20	104296	LED D-RGB Strip- 500/130 mm	1
21	8202	Screw M3 x 12 DIN7991	2
22	104211	Mylar sticker	2
23	103974	Stand Out (Acetal)	1
24	105932	Main OR 150 x 2 mm	1
25	105935	PCB Cardboard	1

PREPARING THE GRAPHICS CARD

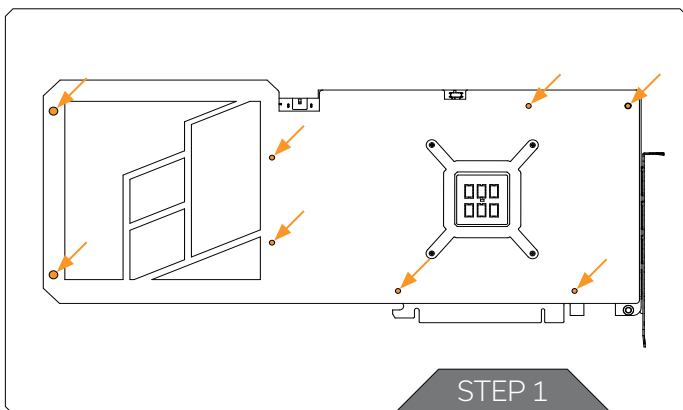

REMOVING THE STOCK COOLER

ASUS TUF GAMING GEFORCE RTX 4090



Important! Before starting, make sure to have a clean, flat surface to work on. It is recommended to put foam or soft material to lay the graphics card on.

STEP 1

First, remove eight (8) screws from the backside of the Stock cooler (using Phillips head screwdriver).

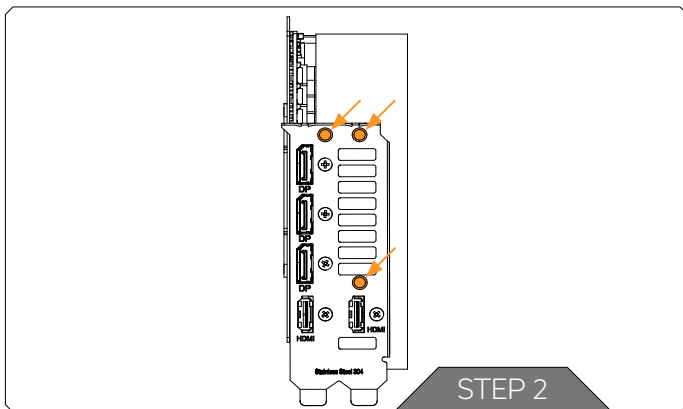

STEP 2

Unscrew three (3) screws from the I/O Bracket (using Phillips head screwdriver). Unplug the connectors in order to remove the stock cover from the GPU PCB.

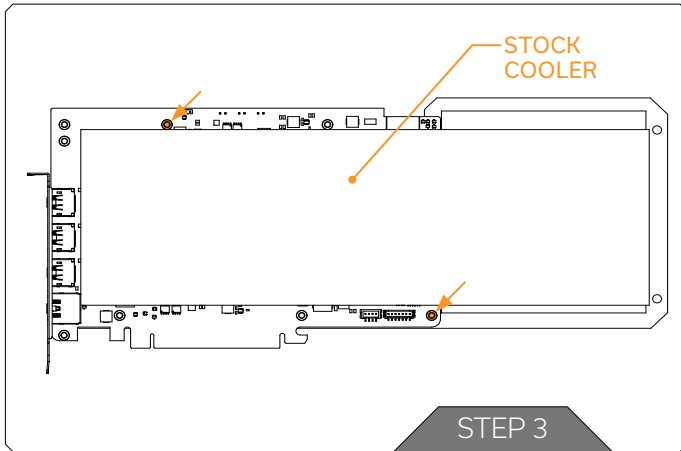

STEP 3

From the front side of the GPU, an additional two (2) screws must be removed (using Phillips head screwdriver). Detach the GPU Backplate.

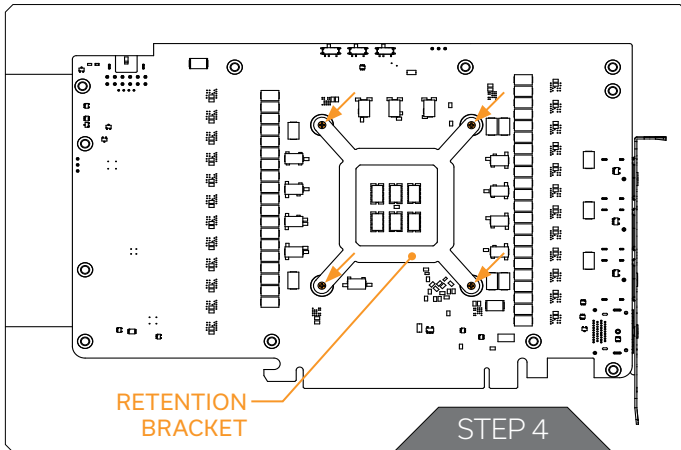

STEP 4

Rotate the GPU and unscrew four (4) Screws from the retention bracket (using Phillips head screwdriver). Remove the bracket and Stock Cooler from the GPU PCB.

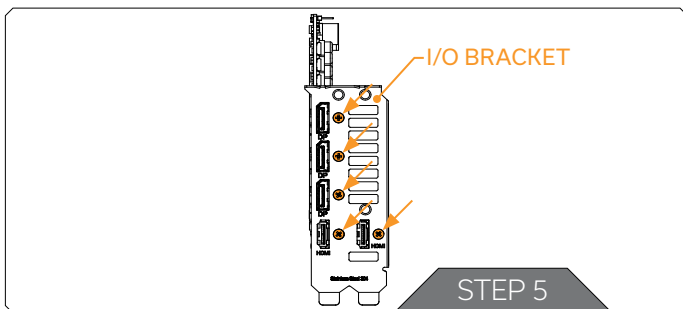

STEP 5

Lastly, unscrew four (4) Screws and detach the I/O Bracket (using Phillips head screwdriver).

EK provides the replacement I/O Bracket with the water block.

PREPARING THE WATER BLOCK FOR INSTALLATION

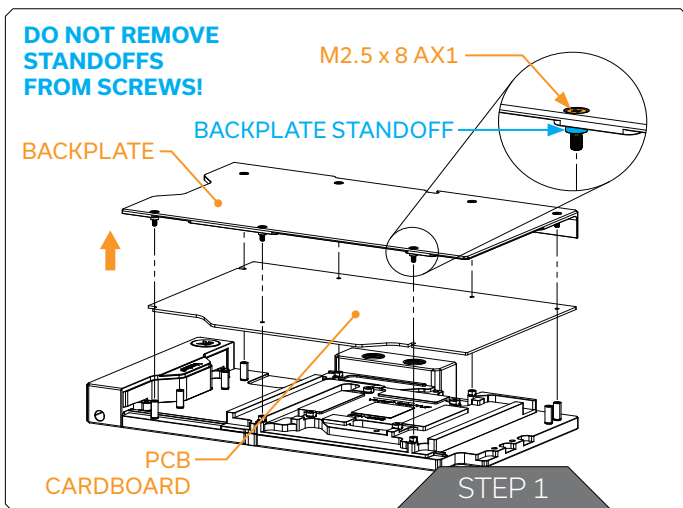

STEP 1

Unscrew seven (7) Screws AX1 M2.5 x 8 mm. Remove the backplate together with the Screws and backplate standoffs. Standoffs must stay on Screws AX1 M2.5 x 8 mm. Remove the PCB cardboard. Save the removed parts for later steps.



Do not remove standoffs from screws! In case the standoff detaches from the screw, replace it with a spare one. When replacing the standoff make sure that you screw it on the AX1 M2.5 x 8 screws. Do not push the standoff onto the screw AX1 M2.5 x 8 mm.

For this step, you will need:

Phillips Head Screwdriver

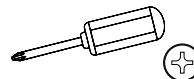

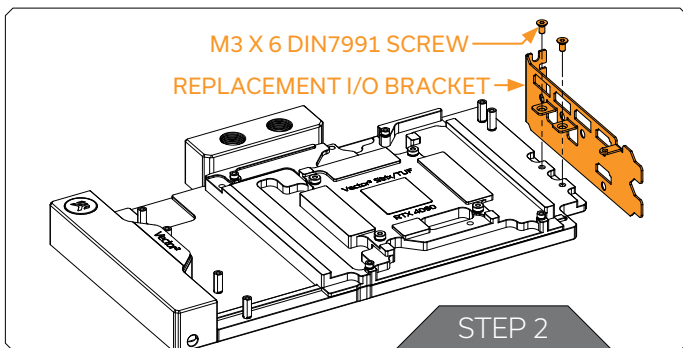

STEP 2

Position the replacement I/O Bracket on the water block. During this process, make sure you have aligned the holes. Secure it with the two (2) M3 x 6 DIN7991 Screws and Allen Key 2 mm.

For this step, you will need:

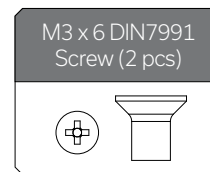
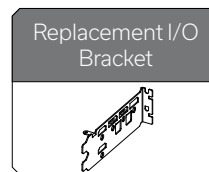
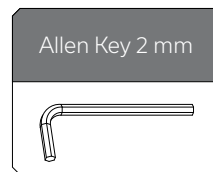

CUTTING AND PLACING THERMAL PADS - Rev 1

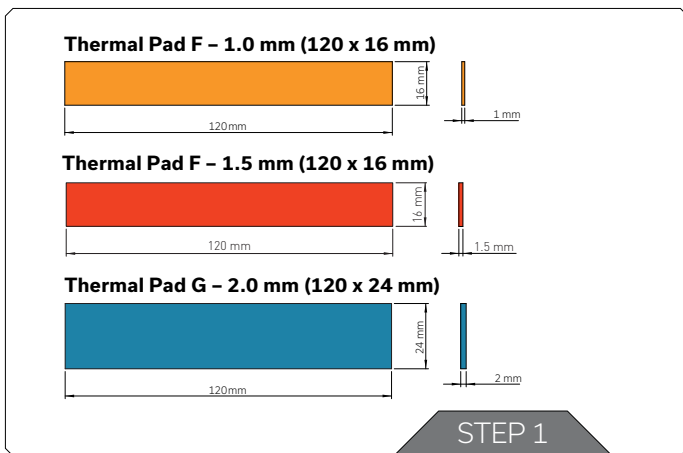

STEP 1

The GPU water block comes with thermal pads that have to be cut into smaller pieces to cover all the VRM components, such as COILS, MOSFETs, and drivers.

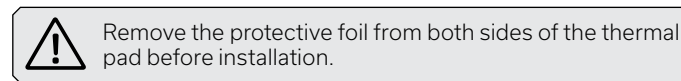

Replacement thermal pads:

Thermal Pad F 1.0 mm – (120 x 16 mm) EAN: 3830046996732

Thermal Pad F 1.5 mm – (120 x 16 mm) EAN: 3830046996749

Thermal Pad G 2.0 mm – (120 x 24 mm) EAN: 3830046996794

CUTTING AND PLACING THERMAL PADS - Rev 2

Thermal Pad F - 1.0 mm (120 x 16 mm)



Thermal Pad G - 1.0 mm (120 x 24 mm)



Thermal Pad G - 2.0 mm (120 x 24 mm)



STEP 1

STEP 1

The GPU water block comes with thermal pads that have to be cut into smaller pieces to cover all the VRM components, such as COILS, MOSFETs, and drivers.



Remove the protective foil from both sides of the thermal pad before installation.

Replacement thermal pads:

Thermal Pad F 1.0 mm - (120 x 16 mm) EAN: 3830046996732

Thermal Pad G 1.0 mm - (120 x 24 mm) EAN: 3830046996770

Thermal Pad G 2.0 mm - (120 x 24 mm) EAN: 3830046996794

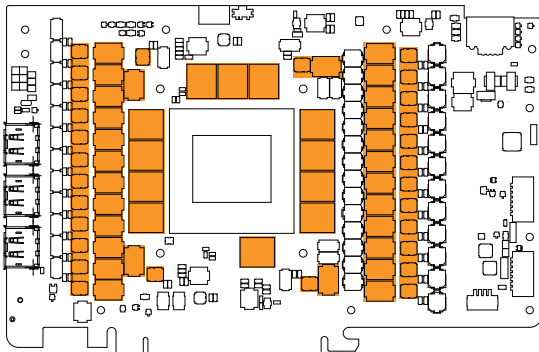

F1 Thermal Pad - 120 x 16 x 1.0 mm

STEP 2

STEP 2

Once cut to the size, Thermal Pads should be placed on the PCB, as shown in the picture:



Before attaching the PCB to the Water Block, make sure all the Thermal Pads are placed correctly!

APPLYING THERMAL COMPOUND

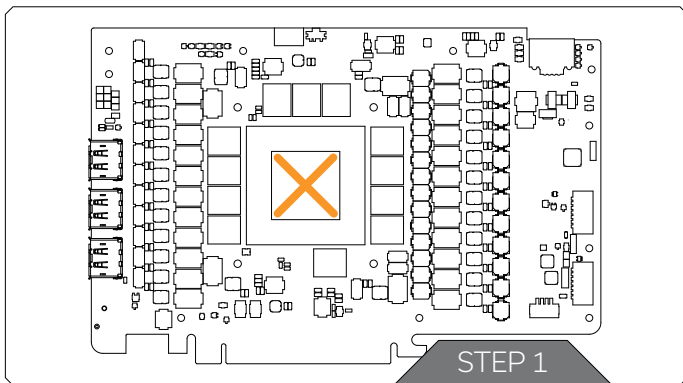

STEP 1

Apply the enclosed thermal grease (thermal compound) on the GPU heat spreader - IHS - as shown in the image. The layer of the thermal compound must be thin and even over the entire surface of the IHS.



The excessive or uneven application of thermal grease may lead to poor performance!

For this step, you will need:

Thermal Grease

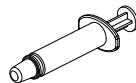

ATTACHING THE WATER BLOCK (Option 1: GeForce RTX 4090 ROG Strix)

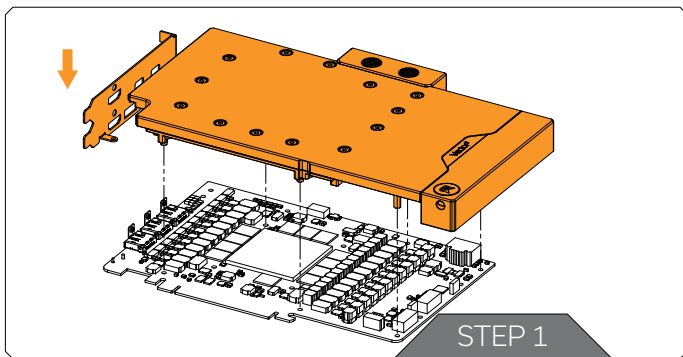

STEP 1

Carefully position the water block with preinstalled standoffs on the graphics card. During this process, make sure you have aligned the mounting holes of the PCB with the holes of the water block.



Pay attention not to use too much force when pressing the block down to the PCB since chip dies are prone to cracking.



Before attaching the PCB to the Water Block, make sure all the Thermal Pads are placed correctly!

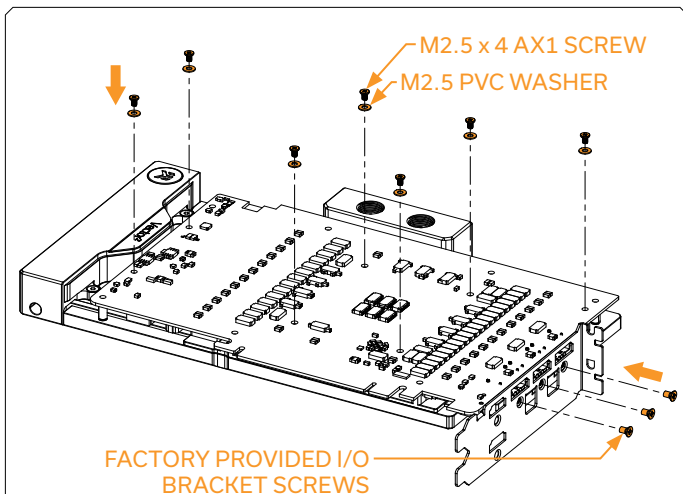

STEP 2

Use seven (7) M2.5 x 4 AX1 Screws and PVC washers to tighten the PCB on the water block. Tighten the screws evenly using the Phillips-head screwdriver. EK recommends you start tightening the screws around the GPU core first, and then continuing outward to prevent damage to the GPU. After attaching the water block, three (3) saved Factory provided I/O Bracket screws can be reused.

For this step, you will need:

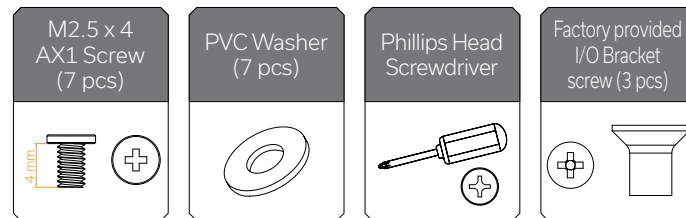

Screws must be present in the places marked on the picture.

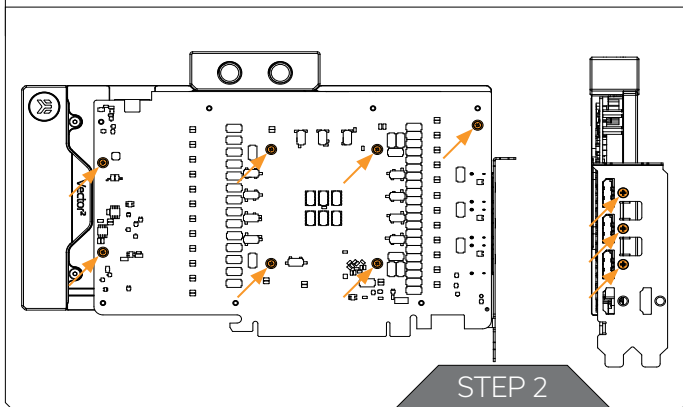

ATTACHING THE WATER BLOCK (Option 2: GeForce RTX 4090 TUF)

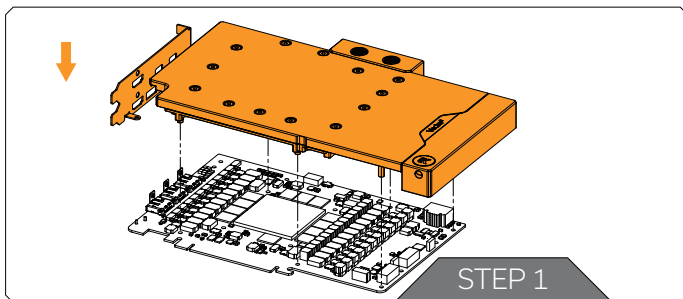

STEP 1

Carefully position the water block with preinstalled standoffs on the graphics card. During this process, make sure you have aligned the mounting holes of the PCB with the holes of the water block.



Pay attention not to use too much force when pressing the block down to the PCB since chip dies are prone to cracking.



Before attaching the PCB to the Water Block, make sure all the Thermal Pads are placed correctly!

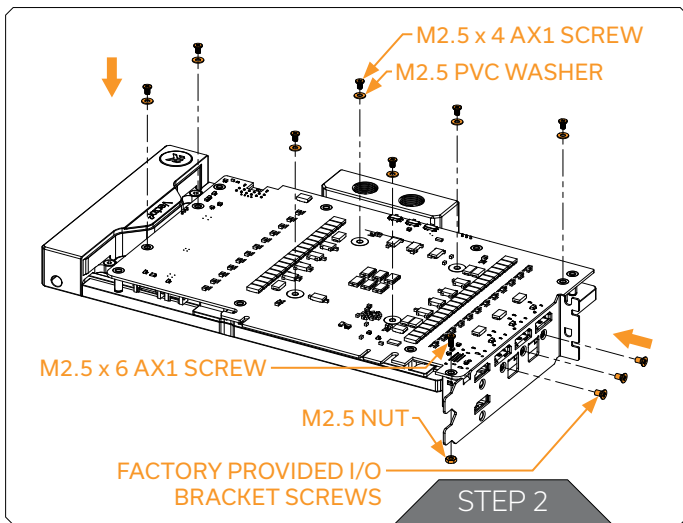

STEP 2

Use seven (7) M2.5 x 4 AX1 Screws and PVC washers to tighten the PCB on the water block. Tighten the screws evenly using the Phillips-head screwdriver. An additional one (1) M2.5 x 6 AX1 Screw must be secured with an M2.5 Nut.

EK recommends you start tightening the screws around the GPU core first, and then continuing outward to prevent damage to the GPU.

After attaching the water block, three (3) saved Factory provided I/O Bracket screws can be reused.

For this step, you will need:

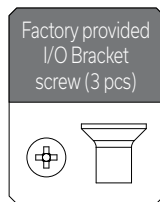
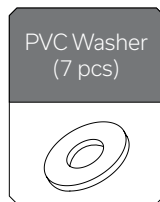
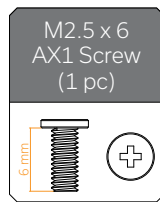
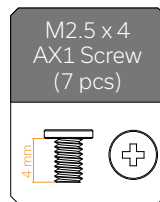

Screws must be present in the places marked on the picture.

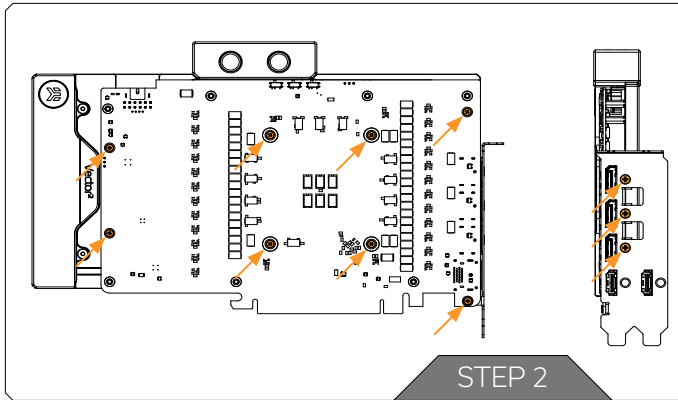

INSTALLING THE BACKPLATE - Rev 1

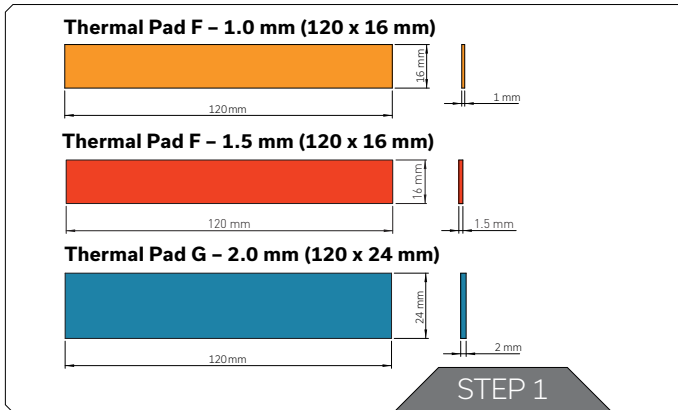

STEP 1

After attaching the water block, a few more thermal pads need to be cut into smaller pieces to cover all the necessary components. EK made sure to provide you with more than an adequate quantity of thermal pads to complete this step.



CAUTION: You must remove the protective foil from both sides of the thermal pad before installation.

Replacement thermal pads:

Thermal Pad F 1.0 mm - (120 x 16 mm) EAN: 3830046996732

Thermal Pad F 1.5 mm - (120 x 16 mm) EAN: 3830046996749

Thermal Pad G 2.0 mm - (120 x 24 mm) EAN: 3830046996794

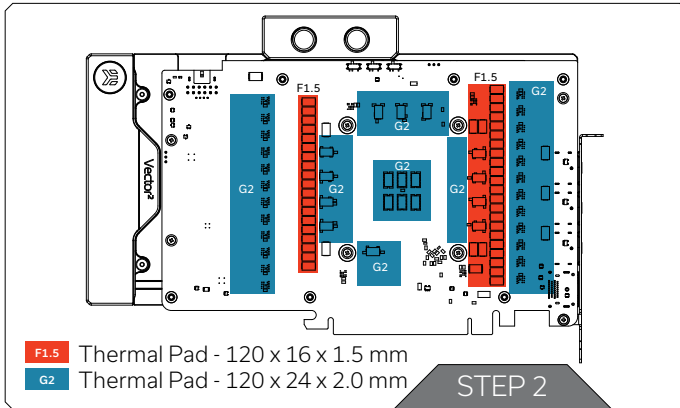

STEP 2

Apply the thermal pads onto the GPU PCB as shown in the image.

INSTALLING THE BACKPLATE - Rev 2

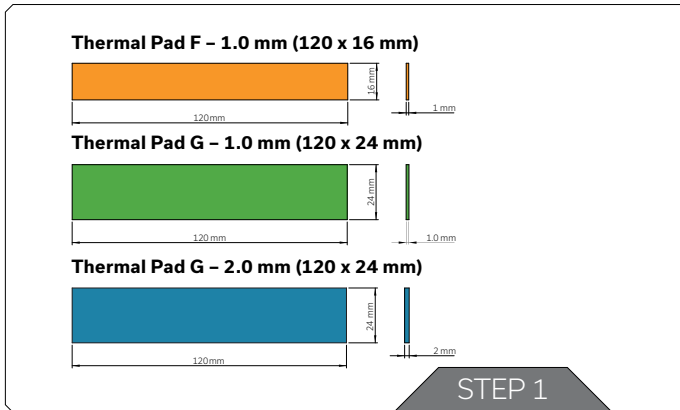

STEP 1

After attaching the water block, a few more thermal pads need to be cut into smaller pieces to cover all the necessary components. EK made sure to provide you with more than an adequate quantity of thermal pads to complete this step.

CAUTION: You must remove the protective foil from both sides of the thermal pad before installation.

Replacement thermal pads:

Thermal Pad F 1.0 mm - (120 x 16 mm) EAN: 3830046996732

Thermal Pad G 1.0 mm - (120 x 24 mm) EAN: 3830046996770

Thermal Pad G 2.0 mm - (120 x 24 mm) EAN: 3830046996794

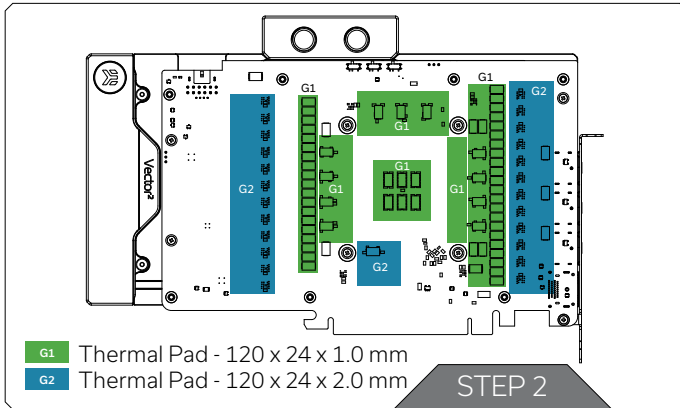

STEP 2

Apply the thermal pads onto the GPU PCB as shown in the image.

ATTACHING THE BACKPLATE

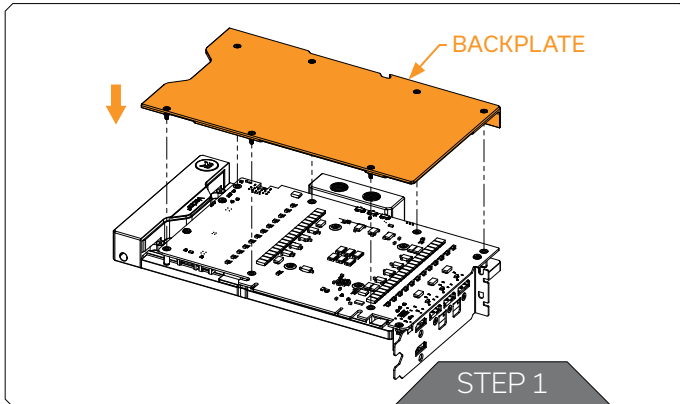

STEP 1

Position the Backplate (including screws and standoffs) onto the GPU PCB. Make sure all the holes are aligned. Tighten the screws evenly.

Before attaching the backplate, make sure all the Thermal Pads are placed correctly!

Do not use excessive force!

For this step, you will need:

Phillips Head Screwdriver

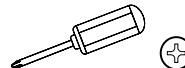

INSERTING THE GRAPHICS CARD INTO THE CHASSIS

Carefully lift your graphics card with the installed water block and insert it into your PC's motherboard PCI Express expansion slot. Please keep in mind that your graphics card is heavier than before it was equipped with the water block.



You need to be very careful when handling the graphics card. Avoid all unnecessary manipulation of the water block assembly that might damage your card or water block.

FITTINGS AND TUBING

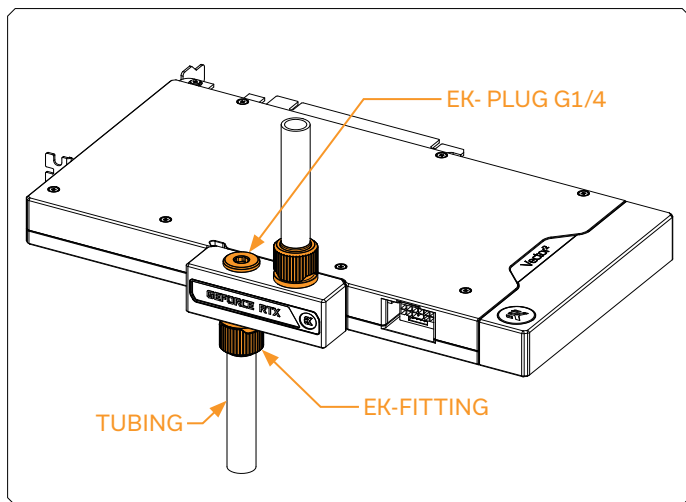

Screw in two (2) G1/4 threaded male fittings. Attach the liquid cooling tubes and connect the water block to the cooling loop.



Do not forget to plug the remaining two openings using the enclosed EK-Plug G1/4 or its equivalent.

EK recommends using EK fittings with all EK water blocks.



CAUTION: When using connectors other than EK fittings, pay special attention to the length of the fittings' male G1/4" thread - 5mm is the maximum G1/4" thread length allowed!

For this step, you will need:

EK-Loop Multi Allen Key



CONNECTING THE D-RGB LED STRIP

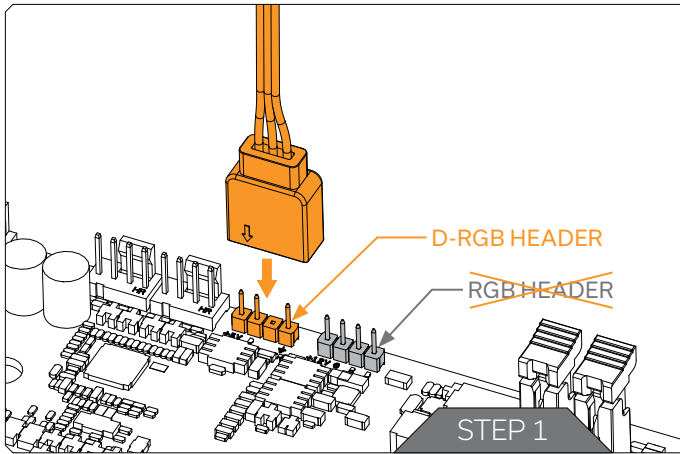

STEP 1

Plug the **3-pin connector** of the distribution plate D-RGB LED light to the **D-RGB HEADER** on the motherboard. The LED will work if the pin layout on the header is as follows: **+5V, Digital, Empty, Ground**.



Incorrect installation or installation to a wrong header can damage the LED strip or the header itself!

TESTING THE LOOP

To make sure the installation of EK components was successful, we recommend you perform a leak test for 24 hours. When your loop is complete and filled with coolant, connect the pump to a PSU outside of your system. Do not connect power to any of the other components. Turn on the PSU and let the pump run continuously. It is normal for the coolant level to drop during this process as air collects in the distribution plate. Inspect all parts of the loop, and in the eventuality, that the coolant leaks, fix the issue and repeat the testing process. Ensure that all hardware is dry before the system is powered on in order to prevent any damage.

WARRANTY

Our products are warranted against defects of materials and quality for a period of 24 months, starting with the date of delivery to the end-user. During this period, products will be repaired or have parts replaced at our discretion, provided that 1) the product is returned to the agent from whom it was purchased; 2) the product has been purchased by the end-user and has not been used for commercial purposes; 3) the product has not been misused, handled carelessly, or used in a manner other than the way described in the instruction's manual. This warranty does not confer rights other than those expressly set out above and does not cover any claims for consequential loss or damage. This warranty is offered as an extra benefit and does not affect your statutory rights as a consumer. This warranty is voided if the product comes in contact with aggressive UV additives or other improper liquids. EK Water blocks are sealed with a warranty-voiding circular label, proving the water block has withstood a pressure leak test. Removing the label will void the leak-free guarantee, but not the guarantee on the product itself. Any other RMA issues can be reported to EK Customer Support at www.ekwb.com/support for further analysis.

SUPPORT AND SERVICE

In case you need assistance or wish to order spare parts or a new mounting mechanism, please contact:

<https://www.ekwb.com/customer-support/>

For spare parts orders, refer to the page with "TECHNICAL SPECIFICATIONS AND WATER BLOCK PARTS" where you can find the EAN number of each part you might need.

Include the EAN number with quantity in your request. Mounting Mechanism EAN can be found under "BOX CONTENTS"

Thermal pads are readily available in the EK shop

SOCIAL MEDIA

 EKWaterBlocks

 @EKWaterBlocks

 ekwaterblocks

 EKWBofficial

 ekwaterblocks

