

EK-Quantum Vector² RX 7900 XTX D-RGB - AMD Radeon Edition

GPU WATER BLOCK

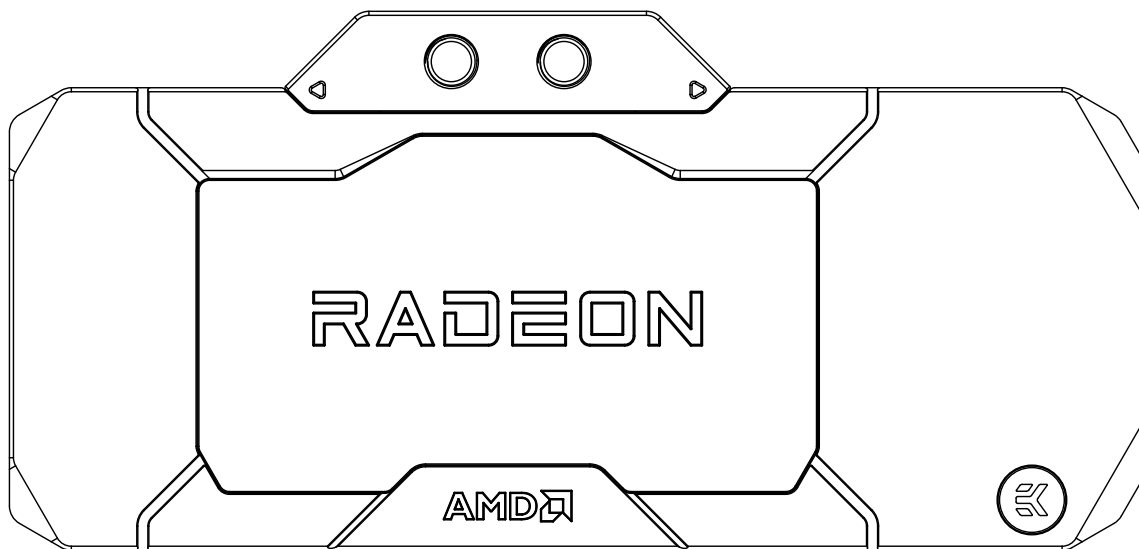

Please note the installation of the product is intended to be undertaken by an adequately trained and experienced person. You are installing the product at your own risk. If you are not properly trained or experienced or feel unsure about the installation procedure, please refrain from installing the product yourself and contact our tech support for assistance. We disclaim our liability for any damages to the product as well as incidental, consequential, or indirect damages incurred due to improper or inappropriate installation.

Before you start using this product, please follow these basic guidelines:

Remove your graphics card from the computer for the safest mounting process to prevent any possible damage to your GPU or its circuit board (PCB).

The EK Fittings require only a small amount of force to screw them firmly in place since the liquid seal is ensured by the rubber O-ring gaskets.

The use of corrosion-inhibiting coolants is always recommended for liquid cooling systems and mandatory for nickel-plated water blocks!

Do not use pure distilled water!

For best results, EK recommends the use of EK-CryoFuel coolants! To reach optimal performance, make sure to thoroughly bleed the air out of your water block!

TABLE OF CONTENTS

BOX CONTENTS	4
WATER BLOCK DIMENSIONS	5
TECHNICAL SPECIFICATIONS AND WATER BLOCK PARTS	6
NICKEL PLEXI	6
PREPARING THE GRAPHICS CARD	7
REMOVING THE STOCK COOLER	7
PREPARING THE WATER BLOCK FOR INSTALLATION	7
CUTTING AND PLACING THERMAL PADS	8
APPLYING THERMAL COMPOUND	9
ATTACHING THE WATER BLOCK	9
INSTALLING THE BACKPLATE	11
ATTACHING THE BACKPLATE	12
INSERTING THE GRAPHICS CARD INTO THE CHASSIS	12
FITTINGS AND TUBING	13
CONNECTING THE D-RGB LED STRIP	13
TESTING THE LOOP	14
WARRANTY	14
SUPPORT AND SERVICE	15
SOCIAL MEDIA	15

BOX CONTENTS

EAN: 106329

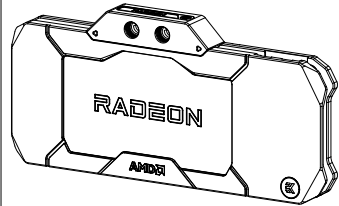

EK-Quantum Vector² RX 7900 XT X
D-RGB - AMD Radeon Edition

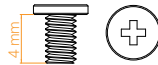

M2.5x4 AX1 Screw (12 pcs)

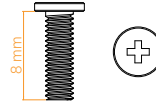

M2.5x8 AX1 Screw (2 pcs)

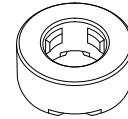

Standoff Ø4.5/2.5 (2 pc)

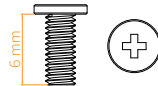

M2.5x6 AX1 Screw (2 pcs)

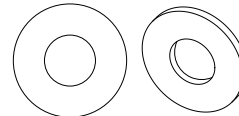

Polyamid Washer M2.5 0.5mm (12 pcs)

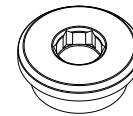

EK Plug G1/4 (2 pcs)

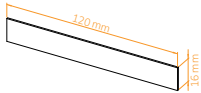

Thermal Pad F 1.0 mm (5 pcs)
(3830046996732)

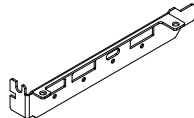

I/O Bracket (1 pc)

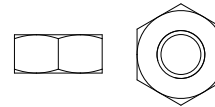

Nut M2.5 (2 pcs)

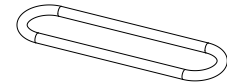

Terminal OR - Vector² 14x1 mm (2 pcs)

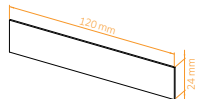

Thermal Pad G 1.0 mm (2 pcs)
(3830046996770)

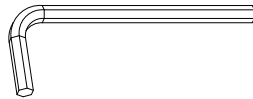

Allen Key 2 mm (1 pc)

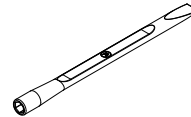

EK-Plug Out Spludger Tool (1 pc)

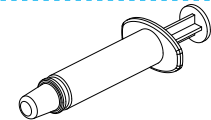

Thermal Grease (1 pc)

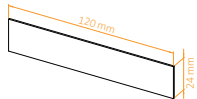

Thermal Pad G 2.0 mm (4 pcs)
(3830046996794)

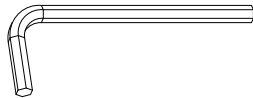

Allen Key 2.5 mm (1 pc)

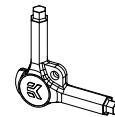

EK-Loop Multi Allen Key (1 pc)

EAN: 106046

WATER BLOCK DIMENSIONS

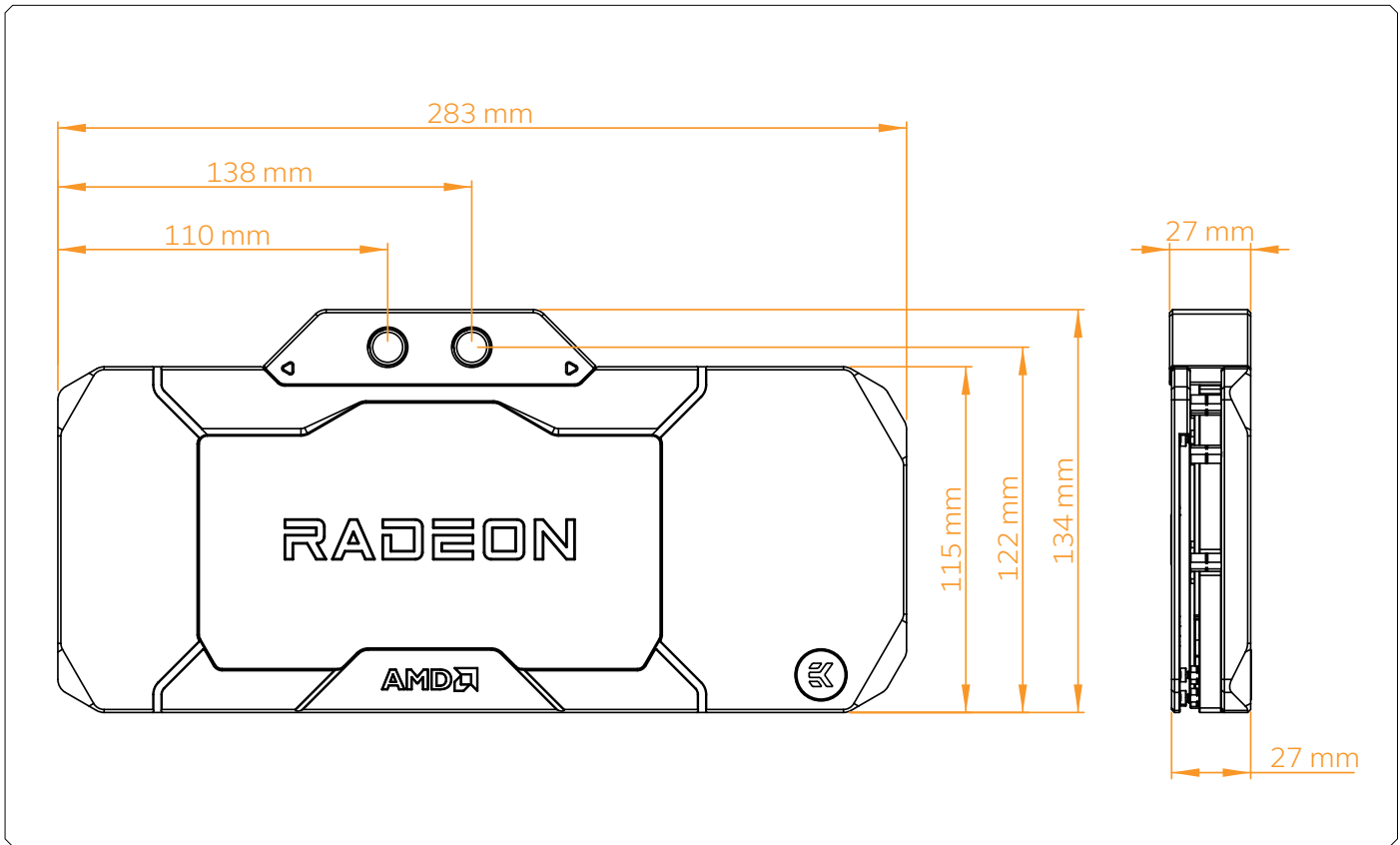

TECHNICAL SPECIFICATIONS AND WATER BLOCK PARTS

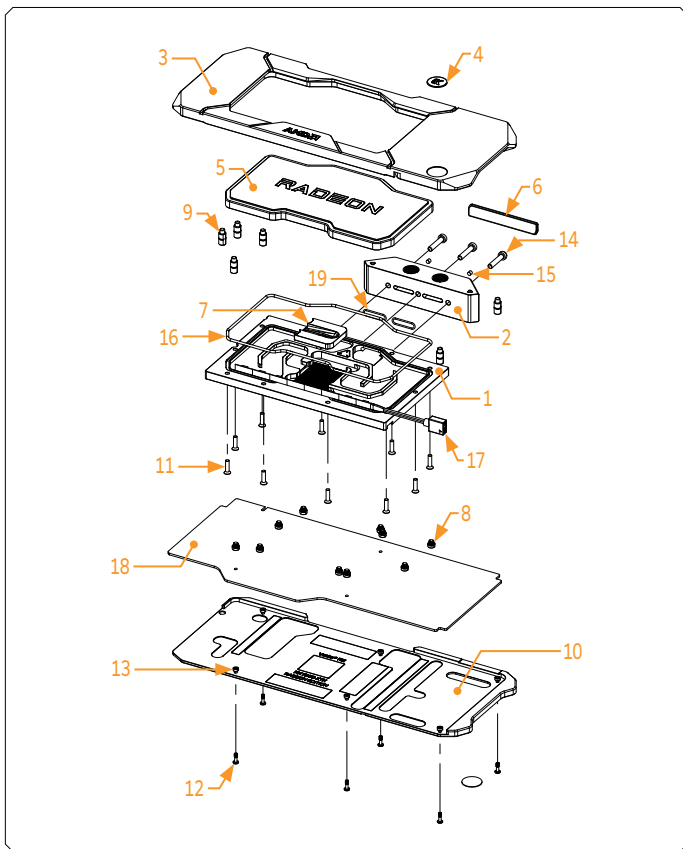

NICKEL PLEXI

- Dimensions: (L x H x W): 282.7 x 134 x 27 mm
- D-RGB LED count: 8
- D-RGB cable length: 500 mm
- D-RGB connector 3-pin 5V digital LED header (Pinout: +5V | Data | Blocked | Ground)

Position	EAN	Description	Quantity
1	106376	Coldplate (Nickel)	1
2	106378	Terminal (Acetal)	1
3	106372	Top Cover (Alu)	1
4	100663	EK RGB Badge	2
5	106377	Top Plate (plexi)	8
6	104345	Terminal Badge	1
7	106133	Plexi Insert	1
8	103988	Standoff M4-M2.5 x 3 mm	10
9	103114	Standoff M4/M2.5 x 10.5 mm	6
10	106371	Backplate (Bl. Elox)	1
11	105032	Screw M3 x 12 ISO 14581 TX	10
12	104187	Screw M2.5 x 8 AX1	6
13	104188	Standoff 4.5/2.5 - Black	6
14	8311	Screw M4 x 20 DIN7984	3
15	104216	Disc Magnet 3 x 3	2
16	100399	OR 148 x 2 EPDM70	1
17	105679	LED D-RGB Strip 500/130 mm	1
18	106382	PCB Cardboard	1
19	104106	Terminal OR - 14 x 1 mm	2

PREPARING THE GRAPHICS CARD

REMOVING THE STOCK COOLER

Place your graphics card on the flat surface and carefully remove the stock cooler. Do not forget to unplug all the LED and fan connectors. Pay attention to the following steps in order to install the water block onto the graphics card

PREPARING THE WATER BLOCK FOR INSTALLATION

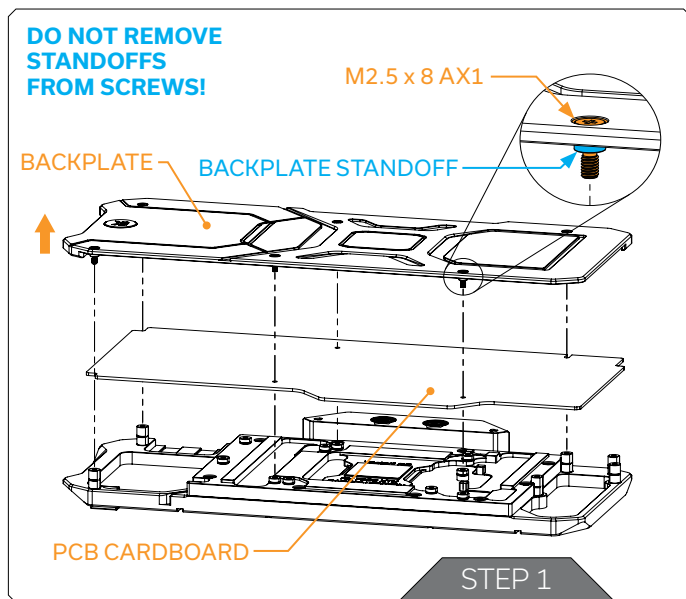

STEP 1

Unscrew six (6) Screws AX1 M2.5 x 8 mm. Remove the backplate together with the Screws and backplate standoffs. Standoffs must stay on Screws AX1 M2.5 x 8 mm. Remove the PCB cardboard. Save the removed parts for later steps.



Do not remove standoffs from screws! In case the standoff detaches from the screw, replace it with a spare one. When replacing the standoff make sure that you screw it on the AX1 M2.5 x 8 screws. Do not push the standoff onto the screw AX1 M2.5 x 8 mm.

For this step, you will need:

Phillips Head Screwdriver

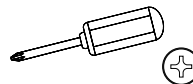

CUTTING AND PLACING THERMAL PADS

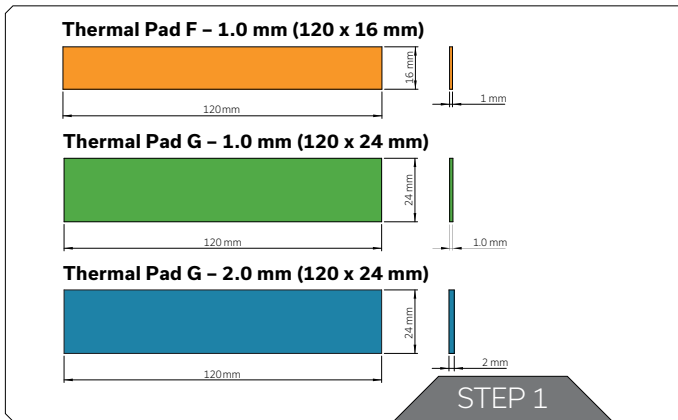

STEP 1

The GPU water block comes with thermal pads that have to be cut into smaller pieces to cover all the VRM components, such as COILS, MOSFETs, and drivers.



Remove the protective foil from both sides of the thermal pad before installation.

Replacement thermal pads:

Thermal Pad F 1.0 mm – (120 x 16 mm) EAN: 3830046996732

Thermal Pad G 1.0 mm – (120 x 24 mm) EAN: 3830046996770

Thermal Pad G 2.0 mm – (120 x 24 mm) EAN: 3830046996794

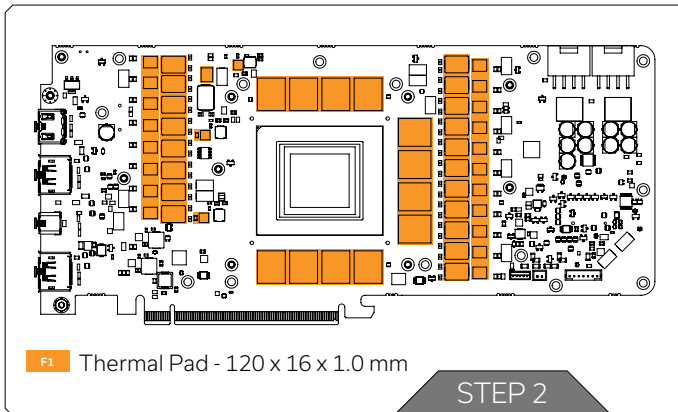

STEP 2

Once cut to the size, Thermal Pads should be placed on the PCB, as shown in the picture.

APPLYING THERMAL COMPOUND

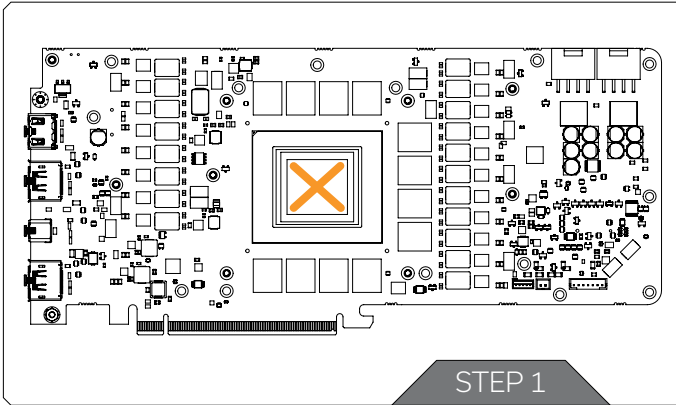

STEP 1

Apply the enclosed thermal grease (thermal compound) on the GPU heat spreader - IHS - as shown in the image. The layer of the thermal compound must be thin and even over the entire surface of the IHS.



The excessive or uneven application of thermal grease may lead to poor performance!

For this step, you will need:

Thermal Grease

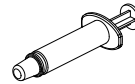

ATTACHING THE WATER BLOCK

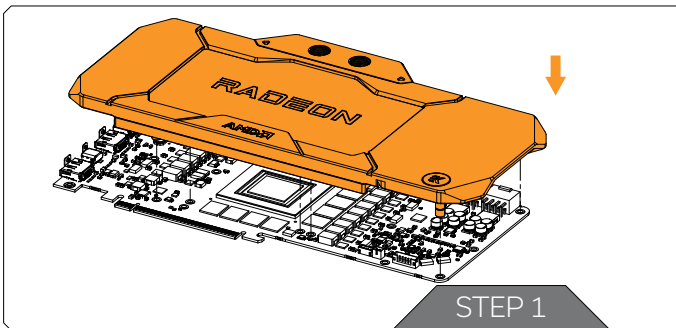

STEP 1

Carefully position the water block with preinstalled standoffs on the graphics card. During this process, make sure you have aligned the mounting holes of the PCB with the holes of the water block.



Pay attention not to use too much force when pressing the block down to the PCB since chip dies are prone to cracking.



Before attaching the PCB to the Water Block, make sure all the Thermal Pads are placed correctly!

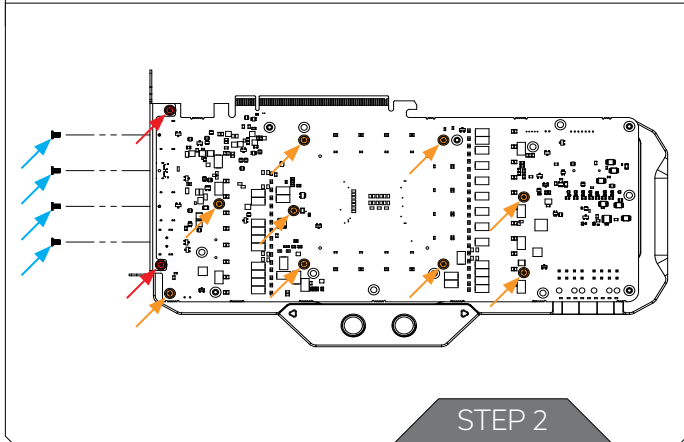
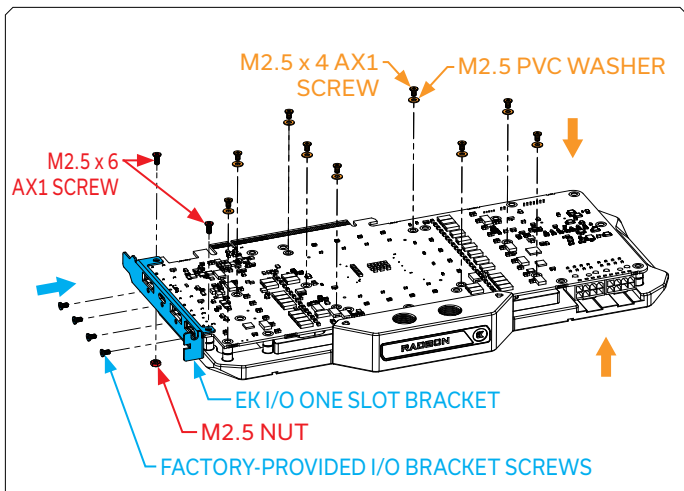

STEP 2

STEP 2

Before securing the GPU PCB, remove the factory I/O Bracket and replace it with provided EK I/O bracket. Tighten the EK I/O bracket with four (4) factory-provided screws from the side and two (2) M2.5 x 6mm screw vertically. You will need to use M2.5 NUT with one (1) M2.5 x 6 screw as seen in the picture. Use nine (9) M2.5 x 4 AX1 Screws and PVC washers to tighten the PCB on the water block. Tighten the screws evenly using the Phillips-head screwdriver. EK recommends you start tightening the screws around the GPU core first, and then continuing outward to prevent damage to the GPU.

For this step, you will need:

- | | | |
|-----------------------------------|--|----------------------------------|
| <p>M2.5 x 4 AX1 Screw (9 pcs)</p> | <p>Polyamide Washer (9 pcs)</p> | <p>Phillips Head Screwdriver</p> |
| <p>EK I/O Bracket</p> | <p>Factory I/O Bracket Screw (4 pcs)</p> | <p>M2.5 x 6 AX1 (2 pcs)</p> |
| <p>M 2.5 Nut (2 pcs)</p> | | |

Screws must be present in the places marked on the picture.

INSTALLING THE BACKPLATE

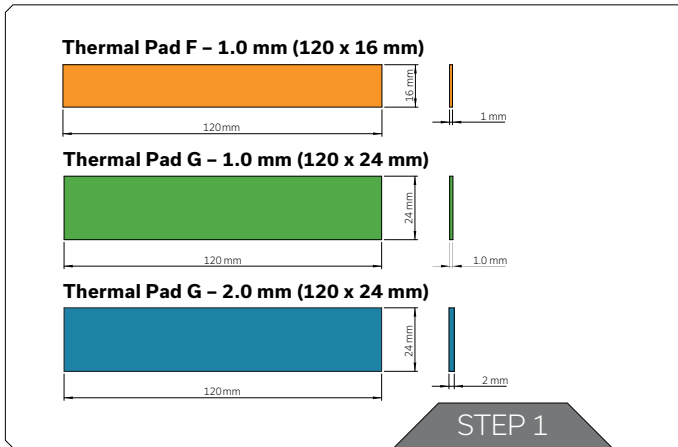

STEP 1

After attaching the water block, a few more thermal pads need to be cut into smaller pieces to cover all the necessary components. EK made sure to provide you with more than an adequate quantity of thermal pads to complete this step.



CAUTION: You must remove the protective foil from both sides of the thermal pad before installation.

Replacement thermal pads:

Thermal Pad F 1.0 mm - (120 x 16 mm) EAN: 3830046996732

Thermal Pad G 1.0 mm - (120 x 24 mm) EAN: 3830046996770

Thermal Pad G 2.0 mm - (120 x 24 mm) EAN: 3830046996794

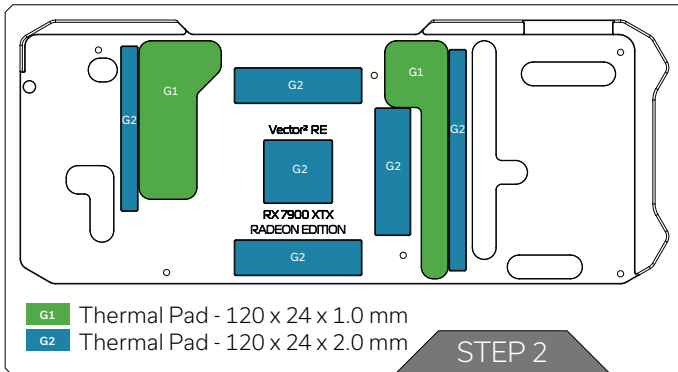

STEP 2

Apply the thermal pads onto the Backplate as shown in the image.

ATTACHING THE BACKPLATE

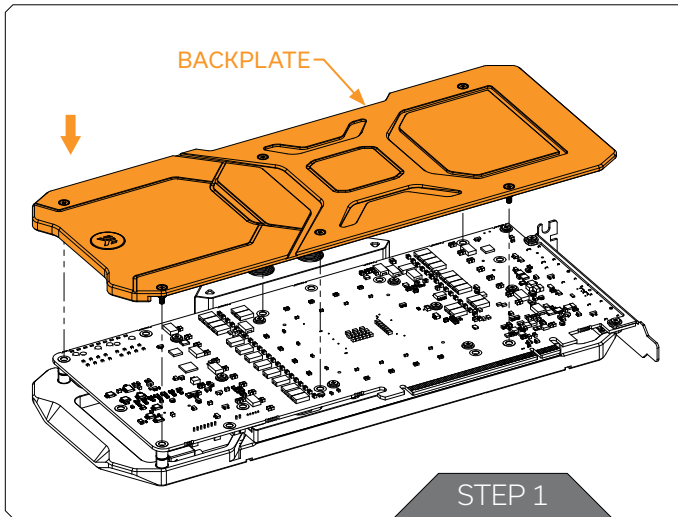

STEP 1

Position the backplate (including screws and standoffs) onto the GPU PCB. Make sure all the holes are aligned. Tighten the screws evenly.

Before attaching the backplate, make sure all the Thermal Pads are placed correctly!

Do not use excessive force!

For this step, you will need:

Phillips Head Screwdriver

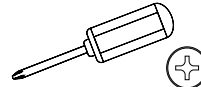

INSERTING THE GRAPHICS CARD INTO THE CHASSIS

Carefully lift your graphics card with the installed water block and insert it into your PC's motherboard PCI Express expansion slot. Please keep in mind that your graphics card is heavier than before it was equipped with the water block.



You need to be very careful when handling the graphics card. Avoid all unnecessary manipulation of the water block assembly that might damage your card or water block.

FITTINGS AND TUBING

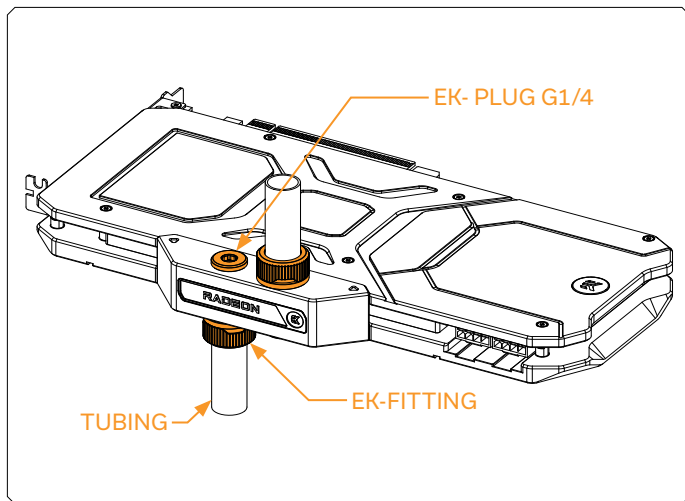

Screw in two (2) G1/4 threaded male fittings. Attach the liquid cooling tubes and connect the water block to the cooling loop.



Do not forget to plug the remaining two openings using the enclosed EK-Plug G1/4 or its equivalent.

EK recommends using EK fittings with all EK water blocks.



CAUTION: When using connectors other than EK fittings, pay special attention to the length of the fittings' male G1/4" thread - 5mm is the maximum G1/4" thread length allowed!

For this step, you will need:

EK-Loop Multi Allen Key



CONNECTING THE D-RGB LED STRIP

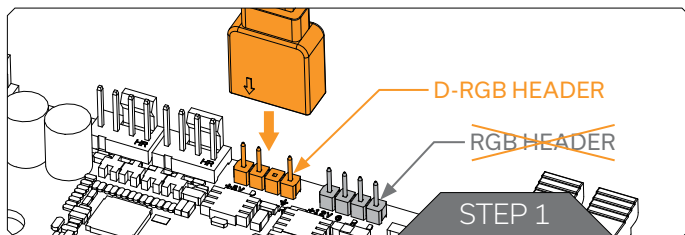

STEP 1

Plug the **3-pin connector** of the distribution plate D-RGB LED light to the **D-RGB HEADER** on the motherboard. The LED will work if the pin layout on the header is as follows: **+5V, Digital, Empty, Ground.**



Incorrect installation or installation to a wrong header can damage the LED strip or the header itself!

TESTING THE LOOP

To make sure the installation of EK components was successful, we recommend you perform a leak test for 24 hours. When your loop is complete and filled with coolant, connect the pump to a PSU outside of your system. Do not connect power to any of the other components. Turn on the PSU and let the pump run continuously. It is normal for the coolant level to drop during this process as air collects in the distribution plate. Inspect all parts of the loop, and in the eventuality, that coolant leaks, fix the issue and repeat the testing process. Ensure that all hardware is dry before the system is powered on in order to prevent any damage.

WARRANTY

Our products are warranted against defects of materials and quality for a period of 24 months, starting with the date of delivery to the end-user. During this period, products will be repaired or have parts replaced at our discretion, provided that 1) the product is returned to the agent from whom it was purchased; 2) the product has been purchased by the end-user and has not been used for commercial purposes; 3) the product has not been misused, handled carelessly, or used in a manner other than the way described in the instruction's manual. This warranty does not confer rights other than those expressly set out above and does not cover any claims for consequential loss or damage. This warranty is offered as an extra benefit and does not affect your statutory rights as a consumer. This warranty is voided if the product comes in contact with aggressive UV additives or other improper liquids. EK Water blocks are sealed with a warranty-voiding circular label, proving the water block has withstood a pressure leak test. Removing the label will void the leak-free guarantee, but not the guarantee on the product itself. Any other RMA issues can be reported to EK Customer Support at www.ekwb.com/support for further analysis.

SUPPORT AND SERVICE

In case you need assistance or wish to order spare parts or a new mounting mechanism, please contact:

<https://www.ekwb.com/customer-support/>

For spare parts orders, refer to the page with "TECHNICAL SPECIFICATIONS AND WATER BLOCK PARTS" where you can find the EAN number of each part you might need.

Include the EAN number with quantity in your request. Mounting Mechanism EAN can be found under "BOX CONTENTS"

Thermal pads are readily available in the EK shop

SOCIAL MEDIA

 EKWaterBlocks

 @EKWaterBlocks

 ekwaterblocks

 EKWBofficial

 ekwaterblocks

