

EK-Quantum Vector² Xtreme RTX 3080/90 D-RGB

GPU WATER BLOCK

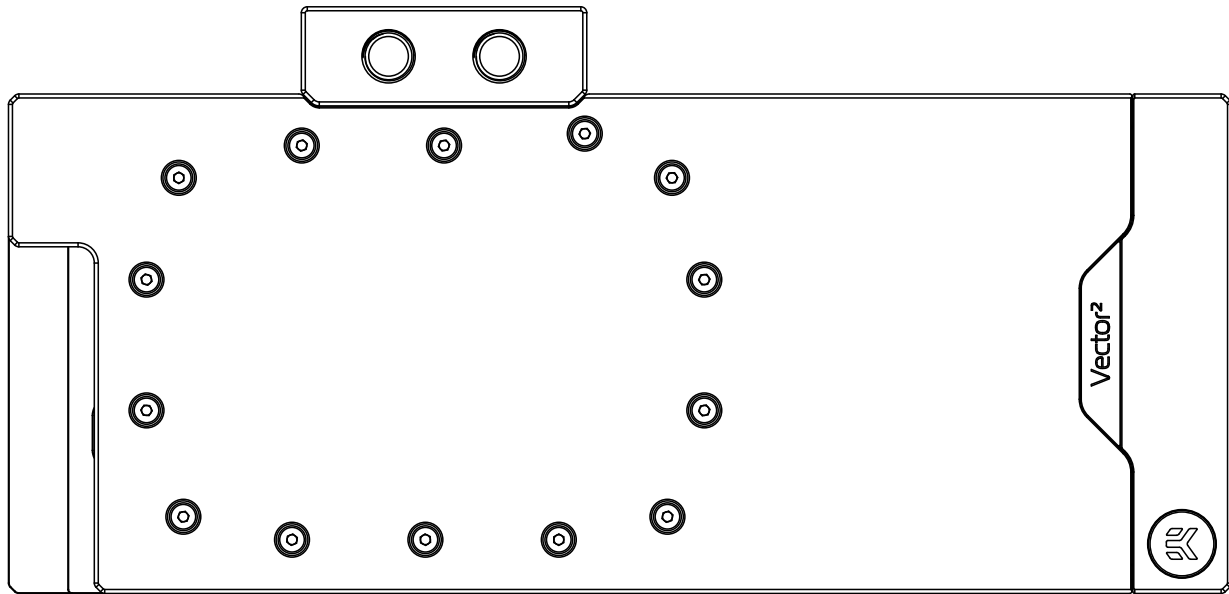

Please note the installation of the product is intended to be undertaken by an adequately trained and experienced person. You are installing the product at your own risk. If you are not properly trained or experienced or feel unsure about the installation procedure, please refrain from installing the product yourself and contact our tech support for assistance. We disclaim our liability for any damages to the product as well as incidental, consequential, or indirect damages incurred due to improper or inappropriate installation.

Before you start using this product, please follow these basic guidelines:

Carefully read the manual before beginning the installation process.

Remove your graphics card from the computer for the safest mounting process to prevent any possible damage to your GPU or its circuit board (PCB).

The EK Fittings require only a small amount of force to screw them firmly in place since the liquid seal is ensured by the rubber O-ring gaskets.

The use of corrosion inhibiting coolants is always recommended for liquid cooling systems and mandatory for nickel-plated water blocks!

Do not use pure distilled water! For best results, EK recommends the use of EK-CryoFuel coolants!

To reach optimal performance, make sure to thoroughly bleed the air out of your water block!

TABLE OF CONTENTS

BOX CONTENTS	4
WATER BLOCK DIMENSIONS	5
TECHNICAL SPECIFICATIONS AND WATER BLOCK PARTS	6
NICKEL PLEXI	6
PREPARING THE GRAPHICS CARD	7
REMOVING THE STOCK COOLER	7
CLEANING THE PCB	7
PREPARING THE WATER BLOCK FOR INSTALLATION	8
CUTTING AND PLACING THERMAL PADS	9
APPLYING THERMAL COMPOUND	10
ATTACHING THE WATER BLOCK	10
PREPARING THE BACKPLATE	12
ATTACHING THE BACKPLATE	14
INSERTING THE GRAPHICS CARD INTO THE CHASSIS	14
FITTINGS AND TUBING	15
CONNECTING THE D-RGB LED STRIP	16
TESTING THE LOOP	16
WARRANTY	17
SUPPORT AND SERVICE	18
SOCIAL MEDIA	18

BOX CONTENTS

EAN: 105161

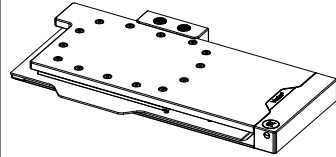

EK-Quantum Vector² Xtreme
RTX 3080/90 D-RGB

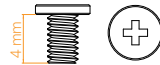

M2.5x4 AX1 Screw (9 pcs)

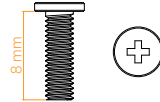

M2.5x8 AX1 Screw (1 pc)

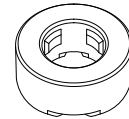

Standoff Ø4.5/2.5 (1 pc)

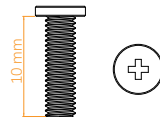

M3x10 AX1 Screw (1 pc)

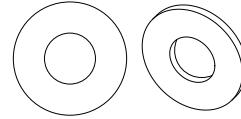

Polyamid Washer M2.5 0.5mm (9 pcs)

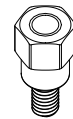

Standoff M2.5-M3 x 6.6mm (1 pc)

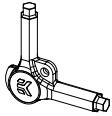

EK-Loop Multi Allen Key (1 pc)

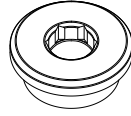

Quantum Plug (2 pcs)

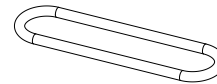

Terminal OR - Vector² 14x1 mm (2 pcs)

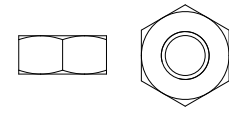

Nut M2.5 (2 pcs)

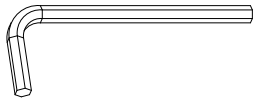

Allen Key 2.5 mm (1 pc)

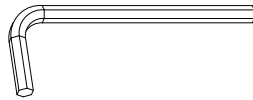

Allen Key 2 mm (1 pc)

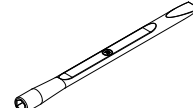

EK-Plug Out Spludger Tool (1 pc)

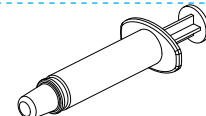

Thermal Grease (1 pc)

EAN: 104549

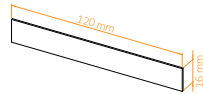

Thermal Pad F 1.0 mm (6 pcs)
(3830046996732)

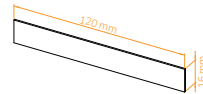

Thermal Pad F 1.5 mm (1 pc)
(3830046996749)

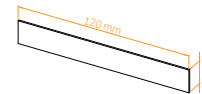

Thermal Pad F 2.0 mm (3 pcs)
(3830046996756)

WATER BLOCK DIMENSIONS

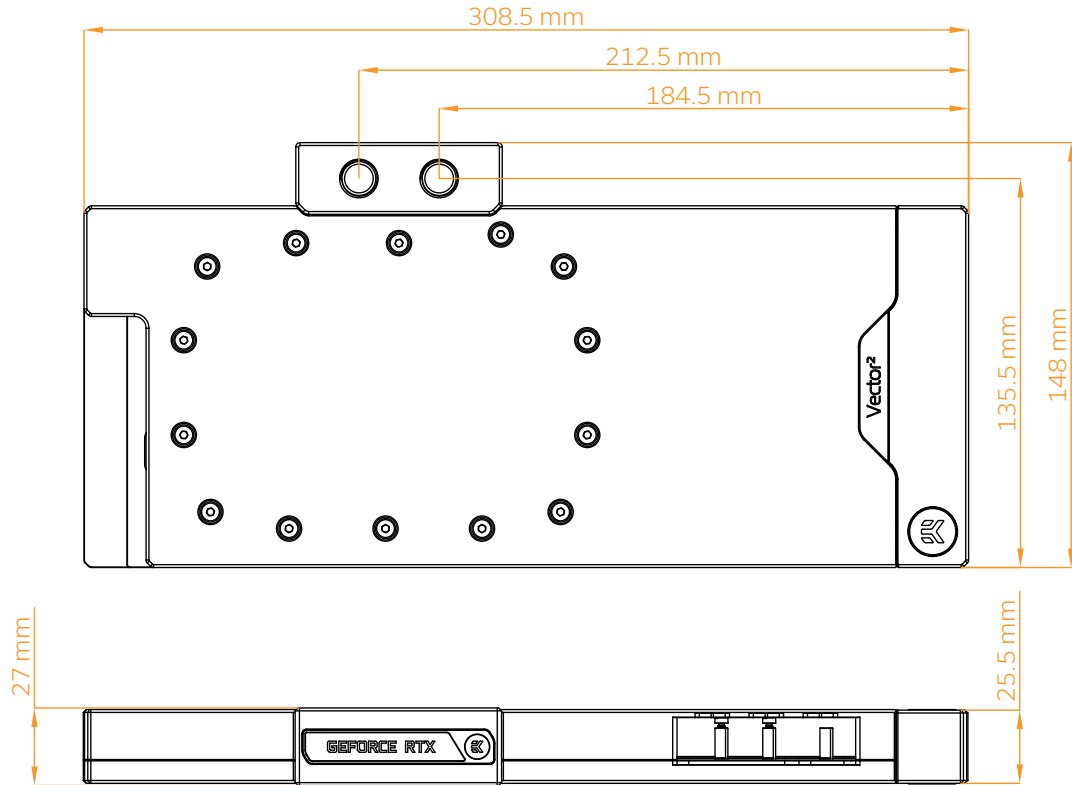

TECHNICAL SPECIFICATIONS AND WATER BLOCK PARTS

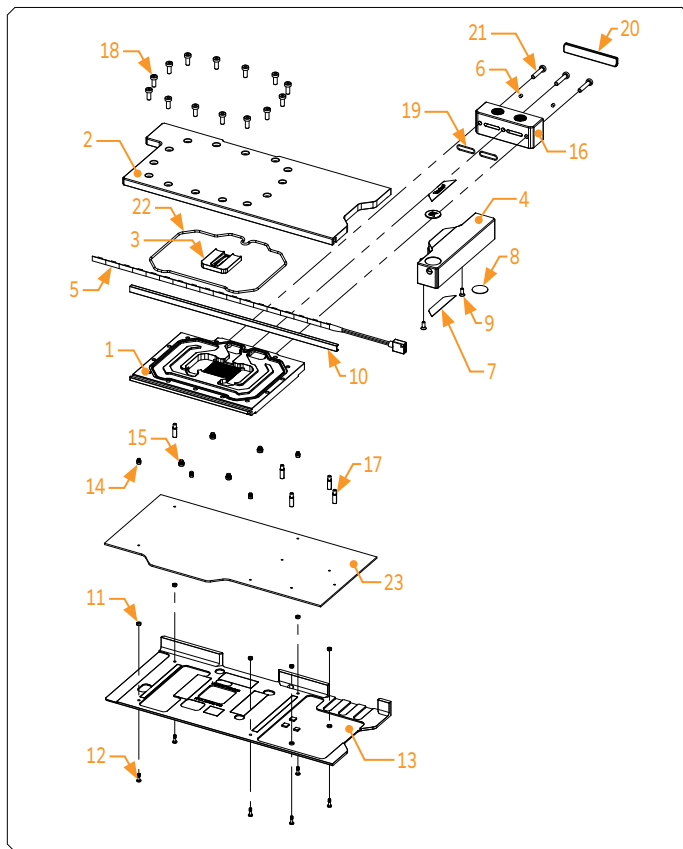

NICKEL PLEXI

- Dimensions: (LxHxW): 308.5 x 148 x 27 mm
- D-RGB LED count: 15
- D-RGB cable length: 50 cm
- D-RGB connector 3-pin 5V digital LED header

Position	EAN	Description	Quantity
1	105139	Coldplate (Nickel)	1
2	105142	Top plate (Plexi)	1
3	103962	Plexi insert	1
4	103970	Stand out (Acetal)	1
5	101556	LED D-RGB strip 500/300 mm	1
6	104216	Disc magnet 3 x 3	2
7	103964	Mylar sticker	2
8	100663	EK - Badge	2
9	8208	Screw M3 x 8 7991DIN	2
10	105148	LED Cover	1
11	104188	Standoff fi 4.5/2.5	6
12	104187	Screw M2.5 x 8 AX1	6
13	105151	Backplate (Black e.)	1
14	103987	Standoff M3.5-M2.5 x 3 mm	4
15	103988	Standoff M4-M2.5 x 3 mm	4
16	103947	FC Terminal (Acetal)	1
17	103986	Standoff M3.5-M2.5 x 11.3 mm	5
18	9024	Screw M4 x 10 DIN7984	14
19	104106	Terminal OR - 14 x 1 mm	2
20	103942	Terminal Badge	1
21	8311	Screw M4 x 20 DIN7984	3
22	104916	OR 138 x 2 mm	1
23	105162	PCB cardboard	1

PREPARING THE GRAPHICS CARD

STEP 1 REMOVING THE STOCK COOLER

Place your graphics card on the flat surface and carefully remove the stock cooler. Do not forget to unplug all the LED and fan connectors. Pay attention to the following steps when installing the EK-Quantum Vector² Xtreme RTX 3080/3090 water block onto your graphics card.

STEP 2 CLEANING THE PCB

Wipe off the remains of the original thermal compound using a nonabrasive cloth or Q-tip, as shown in the sample image, until the components and circuit board are completely clean. EK recommends the use of denatured alcohol for removing TIM leftovers. After that, remove all remaining stock thermal pads from the PCB.

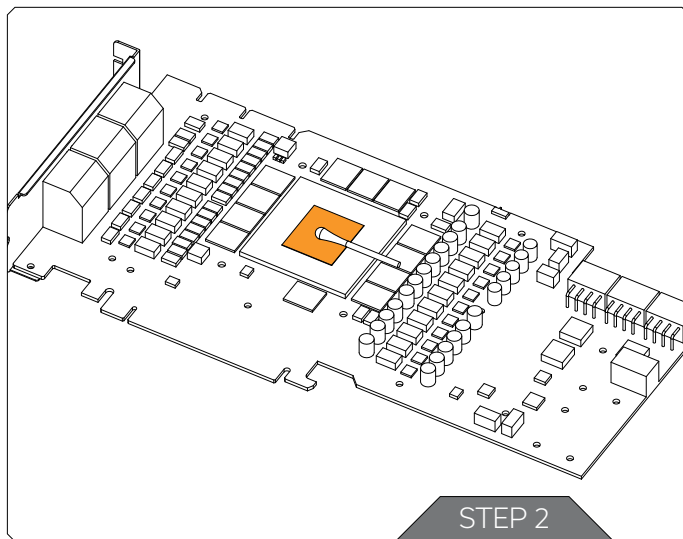

PREPARING THE WATER BLOCK FOR INSTALLATION

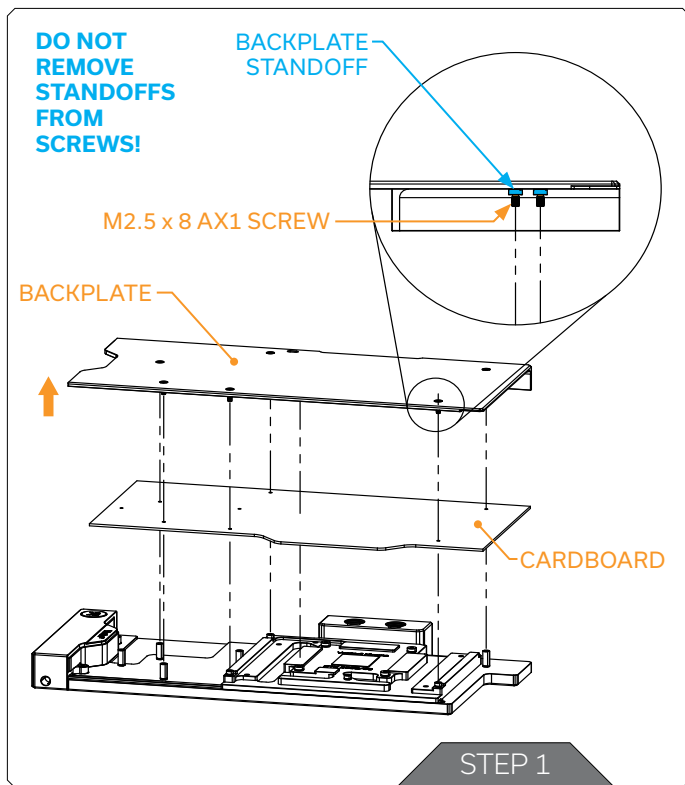

STEP 1

Unscrew six (6) Screws AX1 M2.5x8 as shown in the image. Remove the backplate together with screws and backplate standoffs. Standoffs must stay on Screws M2.5x8 AX1. Remove cardboard. Save the backplate for later steps.



Do not remove standoffs from screws! In case the standoff detaches from the screw, replace it with a spare one. When replacing the standoff make sure that you screw it on the AX1 M2.5 x 8 screw. Do not push the standoff onto the screw AX1 M2.5 x 8!

For this step, you will need:

Phillips Head Screwdriver

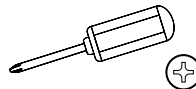

CUTTING AND PLACING THERMAL PADS

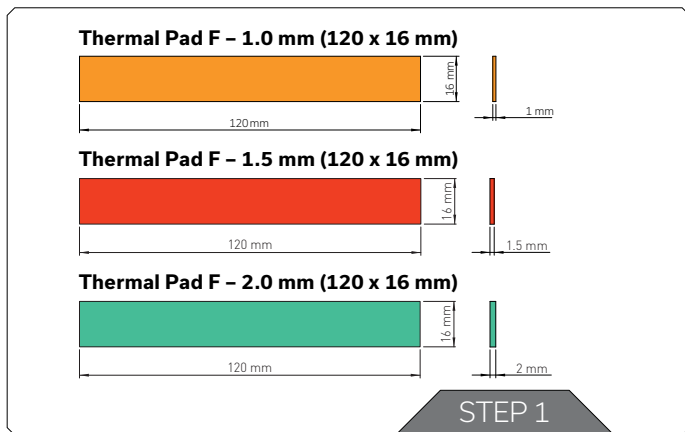

STEP 1

Your EK-Quantum Vector² Xtreme RTX 3080/90 D-RGB block comes with Thermal Pads that have to be cut into smaller pieces to cover all the VRM components. EK made sure to provide you with more than an adequate quantity of Thermal Pads to complete this Step.



CAUTION: You must remove the protective foil from both sides of the thermal pad before installation.

Replacement thermal pads:

Thermal Pad F 1.0 mm – (120 x 16mm) EAN: 3830046996732

Thermal Pad F 1.5 mm – (120 x 16mm) EAN: 3830046996749

Thermal Pad F 2.0 mm – (120 x 16mm) EAN: 3830046996756

For this step, you will need:

Scissors



STEP 2

Once cut to the size, Thermal Pads should be placed on the block, as shown in the picture.



Before attaching the PCB to the Water Block, make sure all the Thermal Pads are placed correctly!

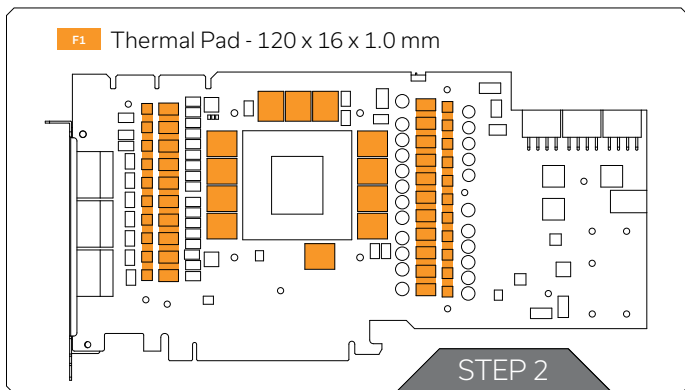

APPLYING THERMAL COMPOUND

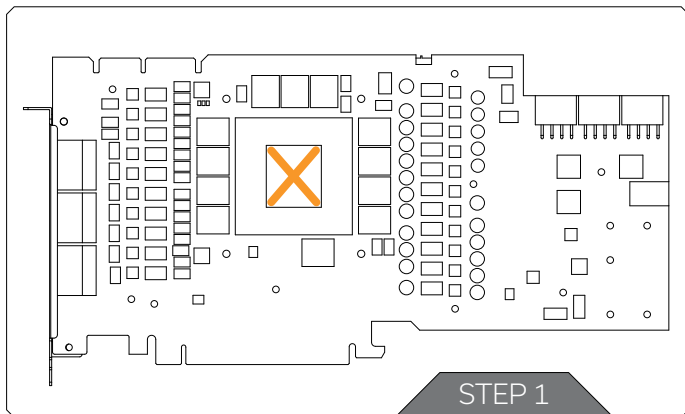

STEP 1

Apply the enclosed EK-TIM Ectotherm thermal grease (thermal compound) on the GPU heat spreader - IHS - as shown in the image. The layer of the thermal compound must be thin and even over the entire surface of the IHS.



The excessive or uneven application of thermal grease may lead to poor performance!

For this step, you will need:

Thermal Grease

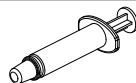

ATTACHING THE WATER BLOCK

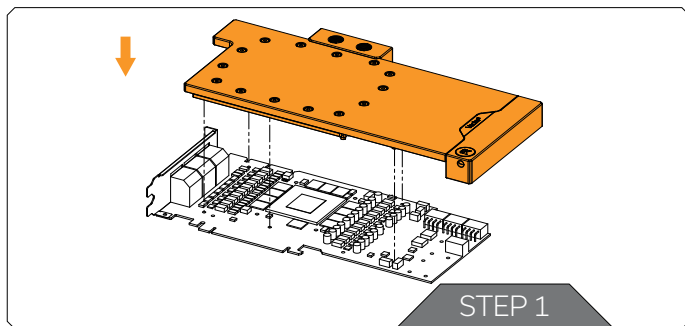

STEP 1

Carefully position the water block with preinstalled standoffs on the graphics card. During this process, make sure you have aligned mounting holes of the PCB with holes of the water block.



Before attaching the PCB to the Water Block, make sure all the Thermal Pads are placed correctly!

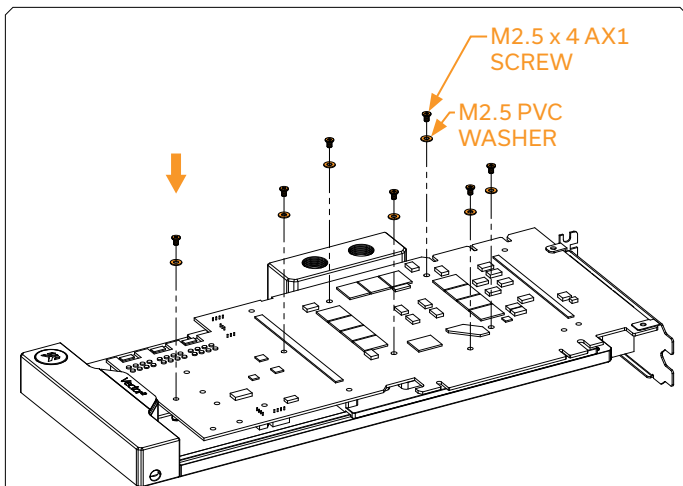

STEP 2

Use seven (7) M2.5 x 4 AX1 Screws and PVC washers to tighten the PCB on the water block. Tighten the screws evenly using the Phillips-head screwdriver.

EK recommends you start tightening the screws around the GPU core first, and then continuing outward to prevent damage to the GPU.

For this step, you will need:

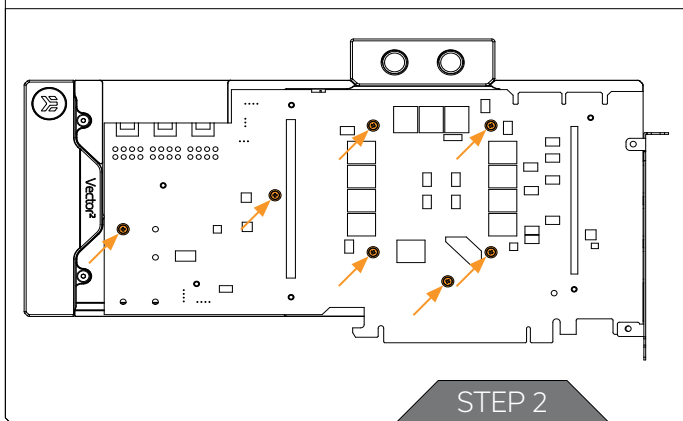
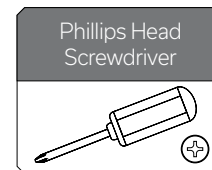
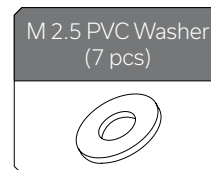
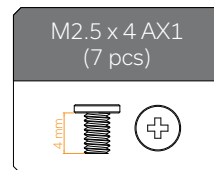

Screws must be present in the places marked on the picture.

PREPARING THE BACKPLATE

Thermal Pad F - 1.0 mm (120 x 16 mm)



Thermal Pad F - 1.5 mm (120 x 16 mm)



Thermal Pad F - 2.0 mm (120 x 16 mm)



STEP 1

STEP 1

After attaching the water block, a few more thermal pads need to be cut into smaller pieces to cover all the necessary components.

EK made sure to provide you with more than an adequate quantity of thermal pads to complete this step.



CAUTION: You must remove the protective foil from both sides of the thermal pad before installation.

Replacement thermal pads:

Thermal Pad F 1.0 mm - (120 x 16mm) EAN: 3830046996732

Thermal Pad F 1.5 mm - (120 x 16mm) EAN: 3830046996749

Thermal Pad F 2.0 mm - (120 x 16mm) EAN: 3830046996756

For this step, you will need:

Scissors

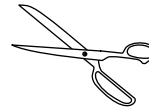

Apply the thermal pads onto the GPU PCB as shown in the image.

- F1** Thermal Pad - 120 x 16 x 1.0 mm
- F1.5** Thermal Pad - 120 x 16 x 1.5 mm
- F2** Thermal Pad - 120 x 16 x 2.0 mm

3080/ 3080Ti:

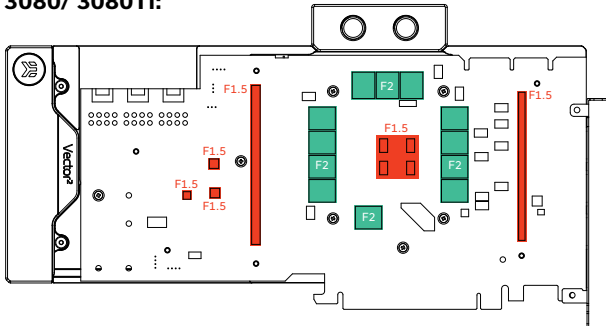

3090:

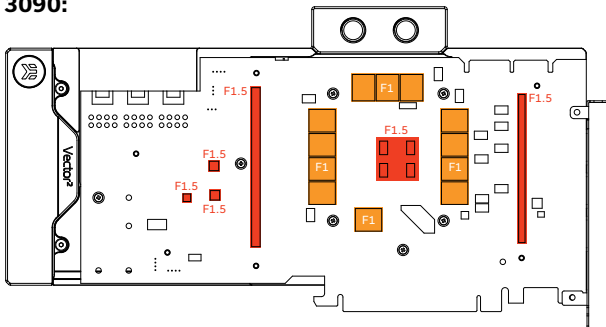

STEP 1

ATTACHING THE BACKPLATE

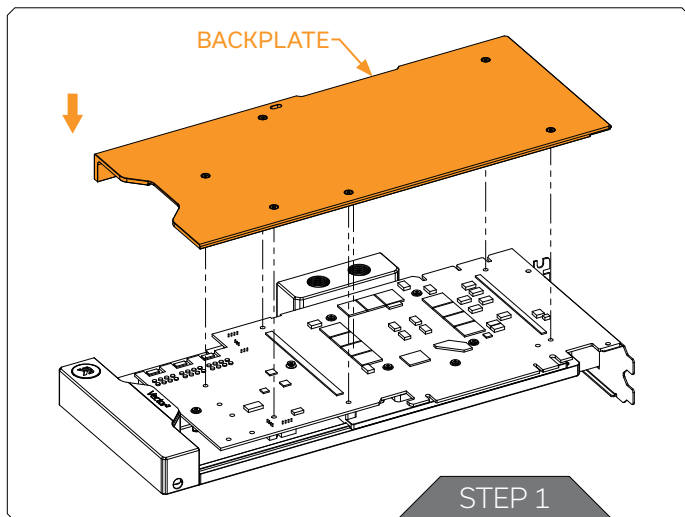

STEP 1

Place the backplate with six (6) M2.5x8 AX1 Screws and Standoffs onto the PCB. Make sure all the holes are aligned.

Do not use excessive force!



Before attaching the backplate, make sure all the Thermal Pads are placed correctly!

For this step, you will need:

Phillips Head Screwdriver

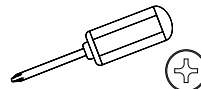

INSERTING THE GRAPHICS CARD INTO THE CHASSIS

Carefully lift your graphics card with the installed water block and insert it into your PC's motherboard PCI Express expansion slot. Please keep in mind that your graphics card is heavier than before it was equipped with the water block.



You need to be very careful when handling the graphics card. Avoid all unnecessary manipulation of the water block assembly that might damage your card or water block.

FITTINGS AND TUBING

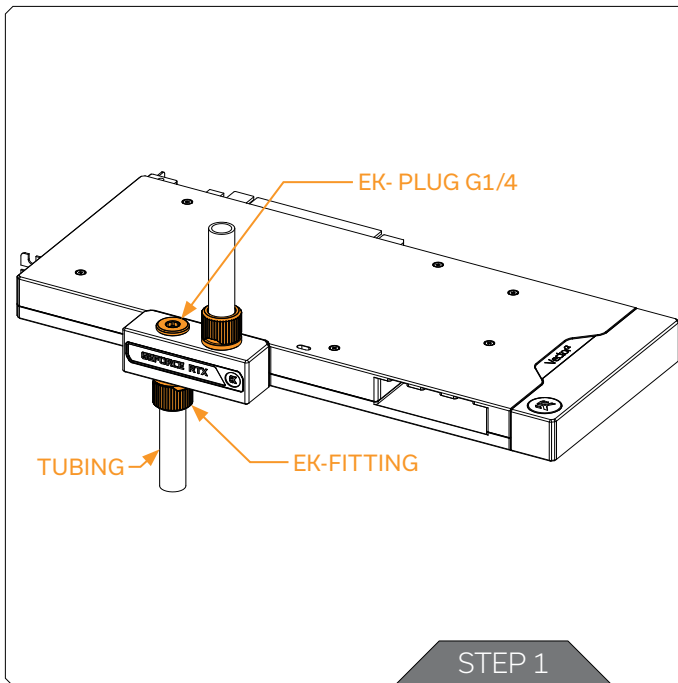

STEP 1

Screw-in two (2) G1/4 threaded male fittings. Attach the liquid cooling tubes and connect the water block to the cooling loop.



Do not forget to plug the remaining two openings using the enclosed EK-Plug G1/4 or its equivalent.

EK recommends using EK fittings with all EK water blocks.



CAUTION: When using connectors other than EK fittings, pay special attention to the length of the fittings' male G1/4" thread - 5mm is the maximum G1/4" thread length allowed!

For this step, you will need:

EK-Loop Multi Allen Key

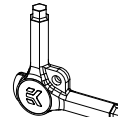

CONNECTING THE D-RGB LED STRIP

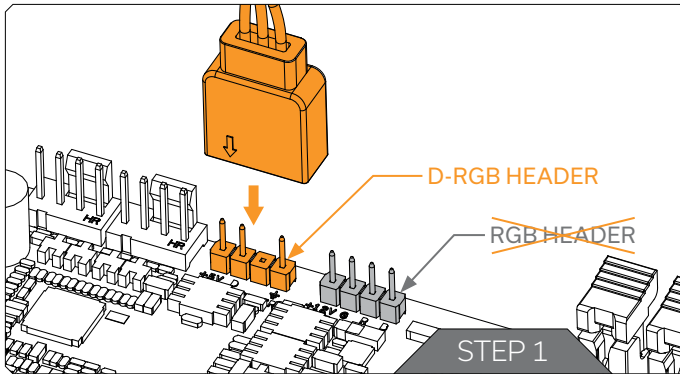

STEP 1

Plug the **3-pin connector** of the distribution plate D-RGB LED light to the **D-RGB HEADER** on the motherboard. The LED will work if the pin layout on the header is as follows: **+5V, Digital, Empty, Ground**.



Incorrect installation or installation to a wrong header can damage the LED strip or the header itself!

TESTING THE LOOP

To make sure the installation of EK components was successful, we recommend you perform a leak test for 24 hours. When your loop is complete and filled with coolant, connect the pump to a PSU outside of your system. Do not connect power to any of the other components. Turn on the PSU and let the pump run continuously. It is normal for the coolant level to drop during this process as air collects in the distribution plate. Inspect all parts of the loop, and in the eventuality that coolant leaks, fix the issue and repeat the testing process. Ensure that all hardware is dry before the system is powered on in order to prevent any damage.

WARRANTY

Our products are warranted against defects of materials and quality for a period of 24 months, starting with the date of delivery to the end-user. During this period, products will be repaired or have parts replaced at our discretion, provided that 1) the product is returned to the agent from whom it was purchased; 2) the product has been purchased by the end-user and has not been used for commercial purposes; 3) the product has not been misused, handled carelessly, or used in a manner other than the way described in the instructions manual. This warranty does not confer rights other than those expressly set out above and does not cover any claims for consequential loss or damage. This warranty is offered as an extra benefit and does not affect your statutory rights as a consumer. This warranty is voided if the product comes in contact with aggressive UV additives or other improper liquids. EK water blocks are sealed with a warranty-voiding circular label, proving the water block has withstood a pressure leak test. Removing the label will void the leak-free guarantee, but not the guarantee on the product itself. Any other RMA issues can be reported to EK Customer Support at www.ekwb.com/support for further analysis.

SUPPORT AND SERVICE

In case you need assistance or wish to order spare parts or a new mounting mechanism, please contact:

<https://www.ekwb.com/customer-support/>

For spare parts orders, refer to the page with "TECHNICAL SPECIFICATIONS AND WATER BLOCK PARTS" where you can find the EAN number of each part you might need.

Include the EAN number with quantity in your request. Mounting Mechanism EAN can be found under "BOX CONTENTS"

Thermal pads are readily available in the EK shop

SOCIAL MEDIA

 EKWaterBlocks

 @EKWaterBlocks

 ekwaterblocks

 EKWBofficial

 ekwaterblocks

