

# EK-Quantum

## Momentum MPG Z590 Gaming Carbon - EK X Edition

MONOBLOCK

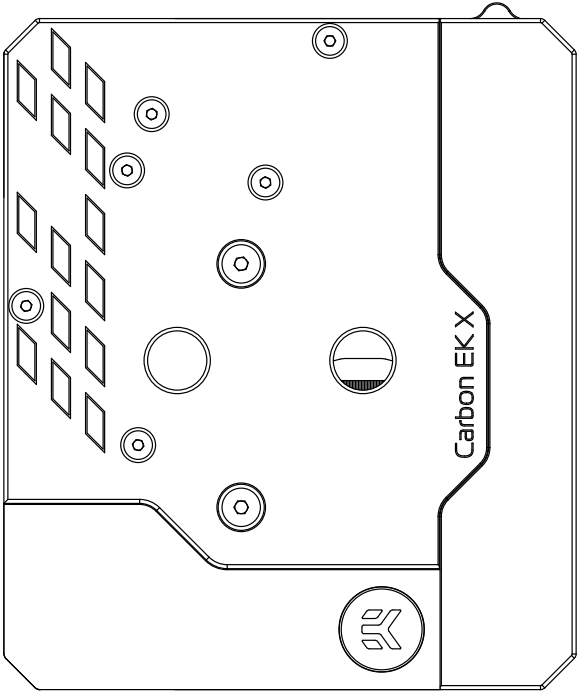

This product is intended for installation by expert users only. Please consult with a qualified technician since improper installation may result in damage to equipment. EK assumes no liability whatsoever, expressed or implied, for the use of this product, nor its installation. The following instructions are subject to change without notice. Please visit our website at [www.ekwb.com](http://www.ekwb.com) for updates. Before installing this product, please read the important notice, disclosure, and warranty stipulation printed on the back of the box.

Before you start using this product please follow these basic guidelines:

**Carefully read the manual before beginning with the installation process!**

**Remove your motherboard from the chassis for the safest mounting process and to prevent damaging your CPU or motherboard's circuit board (PCB).**

**EK Fittings require only a small amount of force to screw them firmly in place since the liquid seal is ensured with the rubber O-ring gaskets.**

**The use of quality market-proven corrosion-inhibiting coolants is always strongly recommended for any liquid cooling system.**

**Do not use pure distilled water as a cooling liquid! For best results, EK recommends the use of EK-CryoFuel Coolants.**

# TABLE OF CONTENTS

<b>BOX CONTENTS</b>	<b>4</b>
<b>PREPARING YOUR MOTHERBOARD</b>	<b>5</b>
REMOVING THE STOCK COOLER	5
APPLYING THERMAL COMPOUND	6
CUTTING AND PLACING THERMAL PADS	7
<b>PLACING THE BLOCK ON THE MOTHERBOARD</b>	<b>8</b>
ATTACHING THE BLOCK ON THE MOTHERBOARD	9
CONNECTING THE D-RGB LED STRIP	10
<b>TESTING THE LOOP</b>	<b>11</b>
<b>SUPPORT AND SERVICE</b>	<b>12</b>
<b>SOCIAL MEDIA</b>	<b>12</b>

# BOX CONTENTS

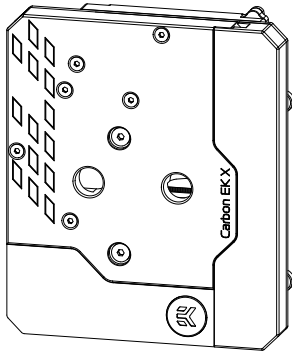

EK-Quantum Momentum MPG Z590 Gaming Carbon - EK X Edition

**Mounting mechanism** - You may not need all the screws, mounting mechanism is universal!

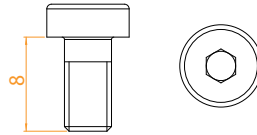

M4 x 8 7984DIN (5 pcs)

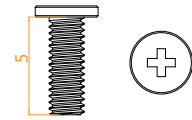

M2.5 x 5 AX1 Screws (5 pcs)

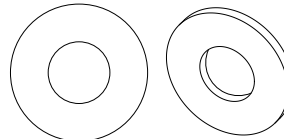

M4 PVC Washers (5 pcs)

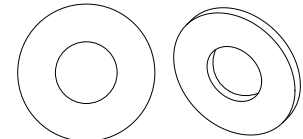

M2.5 PVC Washers (5 pcs)

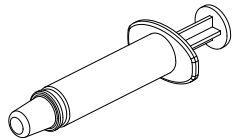

Thermal Grease (1 pc)

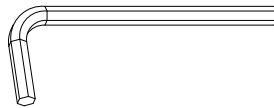

Allen Key 2.5 mm (1 pc)

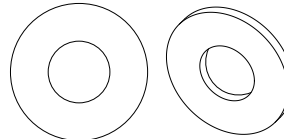

M2.5 Adhesive PVC Washers (5pcs)

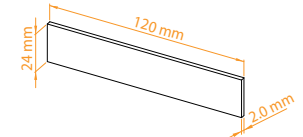

Thermal PAD G 2.0mm - 120x24mm (1 pc)

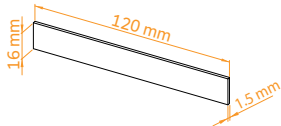

Thermal PAD F 1.5mm - 120x16mm (1 pc)

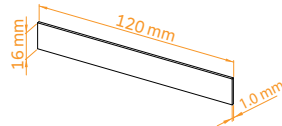

Thermal PAD F 1.0mm - 120x16mm (1 pc)

## PREPARING YOUR MOTHERBOARD

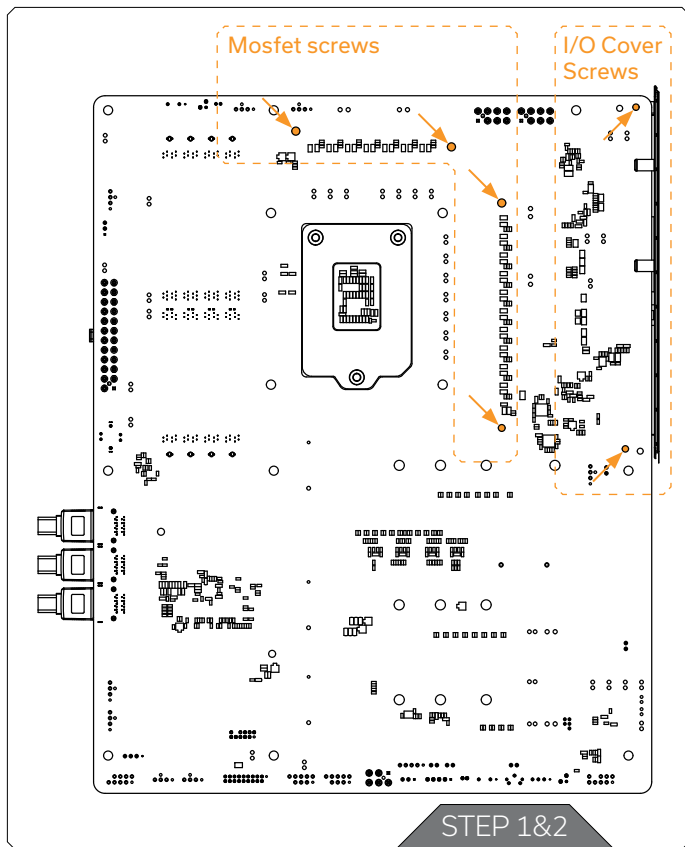

## REMOVING THE STOCK COOLER

### STEP 1

Remove two (2) I/O cover screws from the back of the motherboard. Disconnect the I/O cover cable and remove the I/O cover.

You can attach the I/O cover back on, once you have mounted the Monoblock.

### STEP 2

Remove four (4) MOSFET screws and take off the VRM MOSFET cooler.

## APPLYING THERMAL COMPOUND

Apply the enclosed EK-TIM Ectotherm thermal grease (thermal compound) on the CPU heat spreader – IHS – as shown in the image. The layer of the thermal compound must be thin and even in thickness over the entire surface of the IHS. The excessive or uneven application may lead to poor performance!

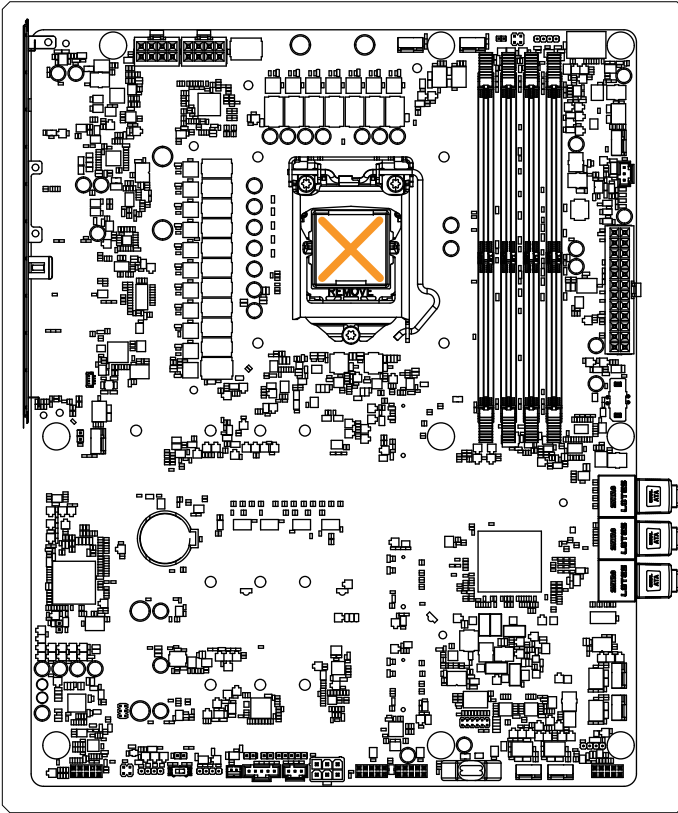

## CUTTING AND PLACING THERMAL PADS

Your water block comes with thermal pads of various dimensions that have to be trimmed to fit MOSFETs and chokes on the motherboard's circuit board.

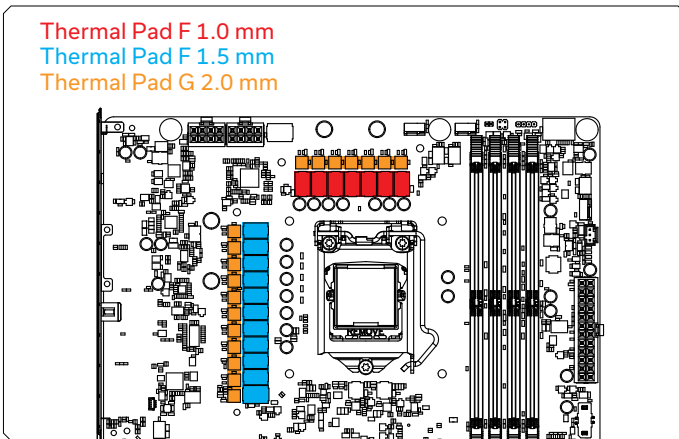
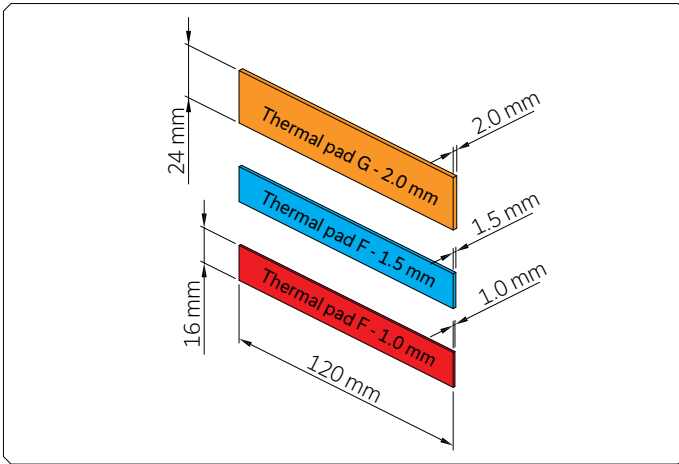

Make sure that you place the thermal pads with the appropriate thicknesses to the correct places on the motherboard, as indicated in the picture.

## PLACING THE BLOCK ON THE MOTHERBOARD

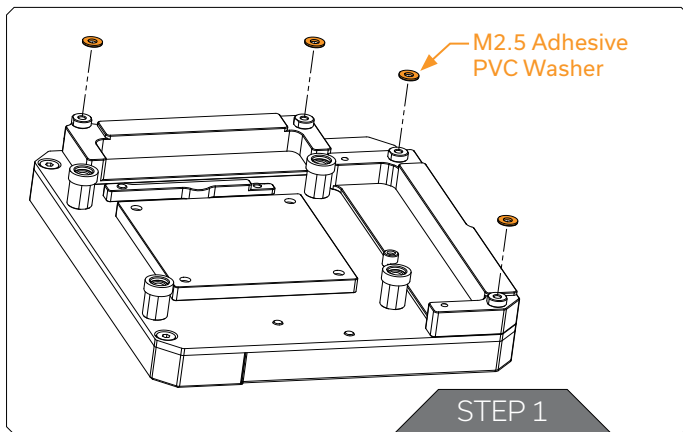

### STEP 1

Stick four (4) M2.5 Adhesive PVC Washers on the appropriate spacers on the monoblock.

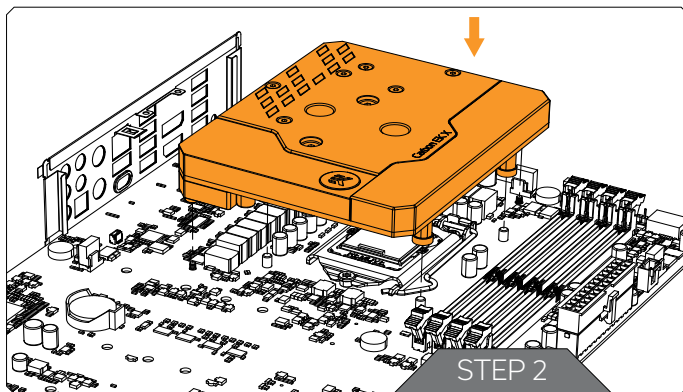

### STEP 2

Place your EK-Quantum Momentum MPG Z590 Gaming Carbon - EK X Edition monoblock on the motherboard, as shown in the picture. Make sure that mounting holes are aligned.

Before placing the monoblock on to the motherboard, make sure that protective sticker on the coldplate is removed!



## FOR CPU

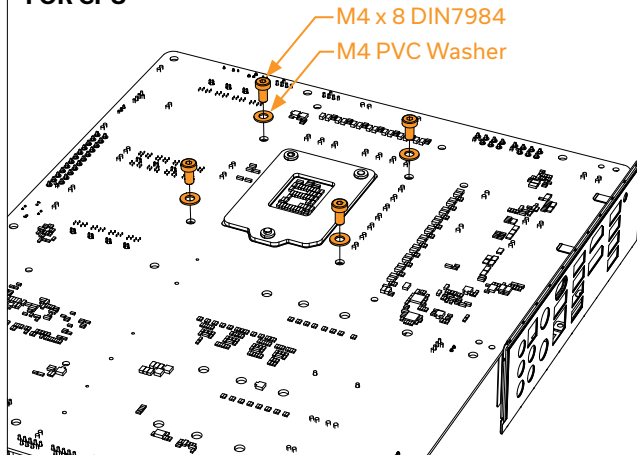

## FOR MOSFET

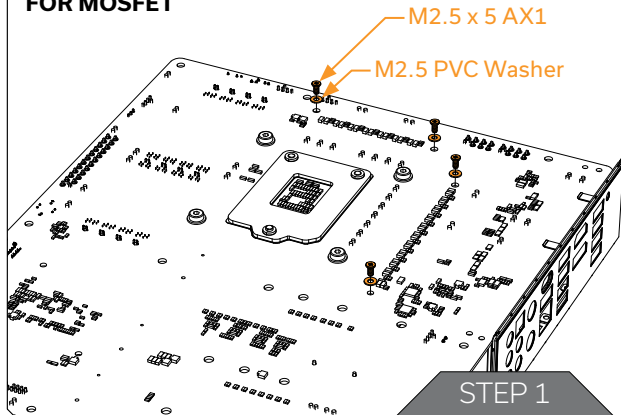

# ATTACHING THE BLOCK ON THE MOTHERBOARD

## STEP 1

Before you fasten the screws, please make sure the mounting holes on the motherboard's circuit board are aligned with the water block. While tightening the screws, do not use excessive force!

### For the CPU:

Use four (4) M4 X 8 DIN7984 screws and M4 PVC washers. Tighten the screws evenly using the enclosed 2.5mm Allen Key.

### For Mosfet:

Use four (4) M2.5 x 5 AX1 screws with M2.5 PVC washers. Tighten the screws evenly.

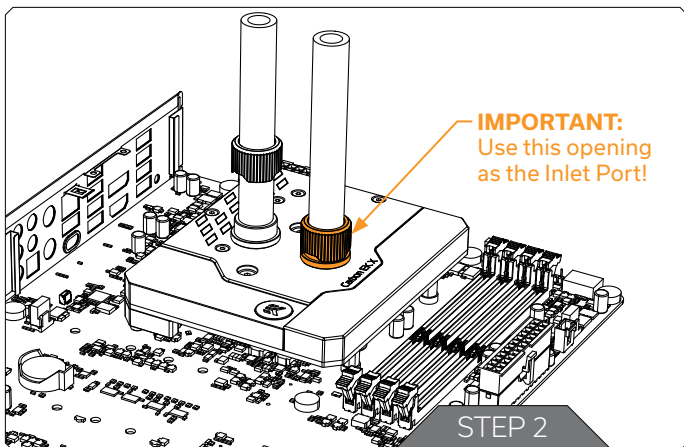

## STEP 2

For the MSI Z590 Pro Carbon monoblock to operate properly, the G1/4 port nearest to the right edge of the water block **MUST BE USED AS THE INLET PORT**.

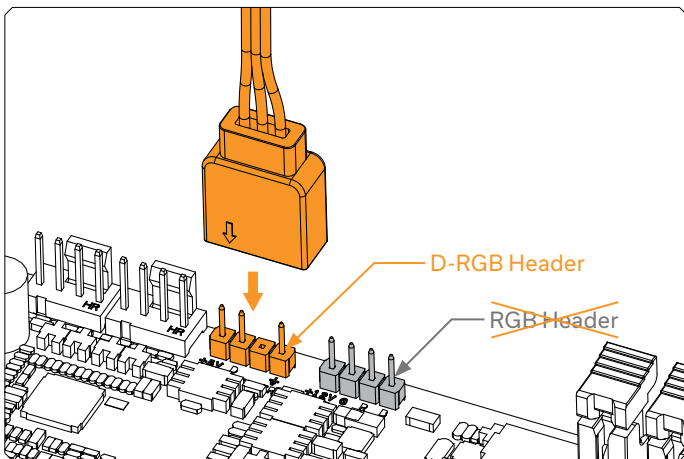

## CONNECTING THE D-RGB LED STRIP

Plug the 3-pin connector from the Monoblock's D-RGB LED light to the **D-RGB Header** on the motherboard. The LEDs will work if the pin layout on the header is as follows: **+5V, Data, Empty, Ground**.

## TESTING THE LOOP

To make sure the installation of EK components was successful, use the EK-Leak Tester to test that the system is watertight. For detailed instructions click on the link below:

<https://www.ekwb.com/shop/EK-IM/EK-IM-3831109816738.pdf>

## SUPPORT AND SERVICE

In case you need assistance, please contact:  
<https://www.ekwb.com/customer-support/>

EKWB d.o.o.  
Pod lipami 18  
1218 Komenda  
Slovenia - EU

## SOCIAL MEDIA

 EKWaterBlocks

 @EKWaterBlocks

 ekwaterblocks

 EKWBofficial

 ekwaterblocks

