

EK-Quantum Vector² Trio RTX 3080/90 D-RGB

GPU WATER BLOCK

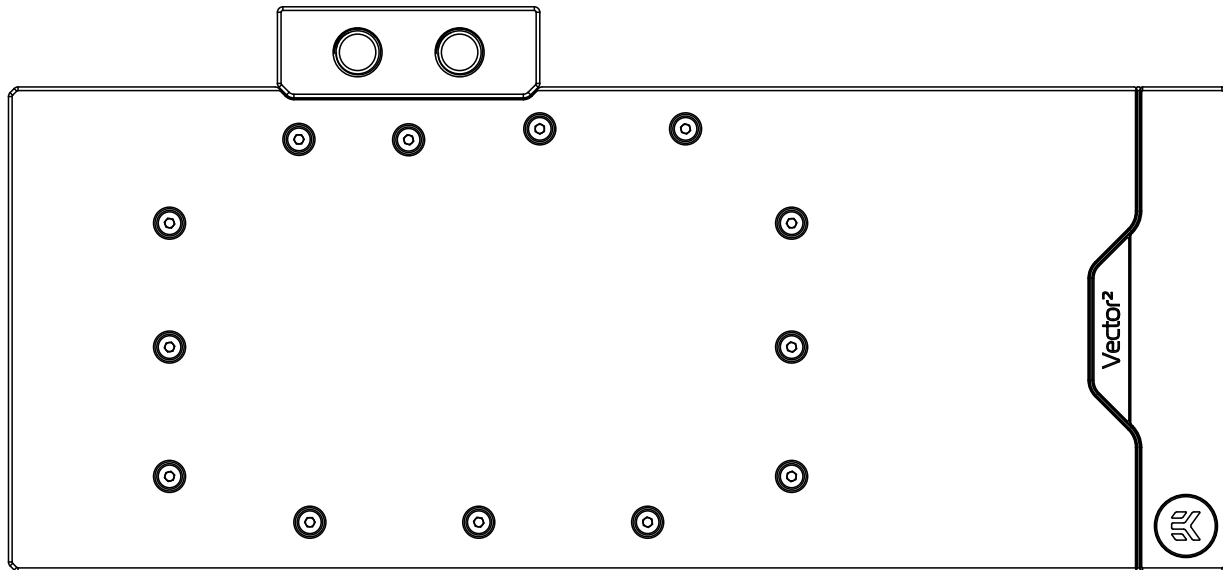

This product is intended for installation by expert users only. Please consult with a qualified technician. Improper installation may result in damage to your equipment. EK assumes no liability whatsoever, expressed or implied, for the use of this product or its installation. The following instructions are subject to change without notice. Please, read the manual carefully before starting the installation process. For updates, you can visit our official website www.ekwb.com.

Before you start using this product, please follow these basic guidelines:

Carefully read the manual before beginning the installation process.

Remove your graphics card from the computer for the safest mounting process to prevent any possible damage to your GPU or its circuit board (PCB).

The EK Fittings require only a small amount of force to screw them firmly in place since the liquid seal is ensured by the rubber O-ring gaskets.

The use of corrosion inhibiting coolants is always recommended for liquid cooling systems and mandatory for nickel-plated water blocks!

Do not use pure distilled water! For best results, EK recommends the use of EK-CryoFuel coolants!





To reach optimal performance, make sure to thoroughly bleed the air out of your water block!

TABLE OF CONTENTS

BOX CONTENTS	4
WATER BLOCK DIMENSIONS	5
TECHNICAL SPECIFICATIONS AND WATER BLOCK PARTS	6
NICKEL PLEXI	6
NICKEL ACETAL	7
PREPARING THE GRAPHICS CARD	8
OPTION 1: USING THE MSI GEFORCE 3080/90 SUPRIM X	8
REMOVING THE STOCK COOLER AND BACKPLATE	8
OPTION 2: USING THE MSI GEFORCE RTX 3080/90 GAMING X TRIO	9
PREPARING THE WATER BLOCK FOR INSTALLATION	10
CUTTING AND PLACING THERMAL PADS	11
APPLYING THERMAL COMPOUND	12
ATTACHING THE WATER BLOCK (Option 1: MSI GEFORCE 3080/3080Ti/3090 SUPRIM X)	12
ATTACHING THE WATER BLOCK (Option 2: MSI GEFORCE 3080/3080Ti/3090 TRIO)	14
PREPARING THE BACKPLATE	15
ATTACHING THE BACKPLATE	17
INSERTING THE GRAPHICS CARD INTO THE CHASSIS	17
FITTINGS AND TUBING	18
CONNECTING THE D-RGB LED STRIP	19
TESTING THE LOOP	19
WARRANTY	20
SUPPORT AND SERVICE	21
SOCIAL MEDIA	21

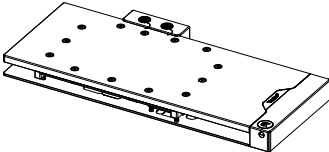
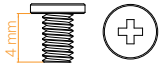
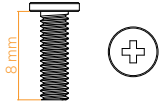
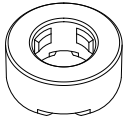
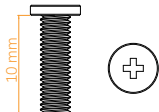
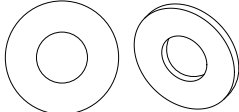
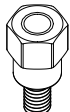
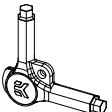
BOX CONTENTS

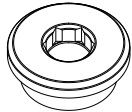
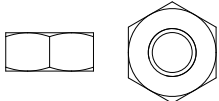
EAN: 104909

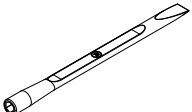
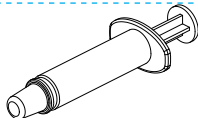
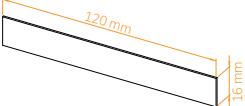
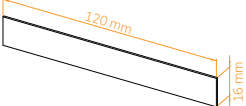
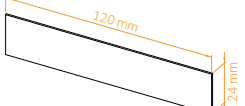
 <p>EK-Quantum Vector² Trio RTX 3080/90 D-RGB</p>	 <p>M2.5x4 AX1 Screw (12 pcs)</p>	 <p>M2.5x8 AX1 Screw (1 pc)</p>	 <p>Standoff Ø4.5/2.5 (1 pc)</p>
<p>EK-Loop Multi Allen Key (1 pc)</p>	 <p>M3x10 AX1 Screw (1 pc)</p>	 <p>Polyamid Washer M2.5 0.5mm (12 pcs)</p>	 <p>Standoff M2.5-M3 x 6.6mm (1 pc)</p>
 <p>EK-Loop Multi Allen Key (1 pc)</p>	 <p>Standoff M3.5-M2.5 x 11.3mm (1 pc)</p>	 <p>Quantum Plug (2 pcs)</p>	 <p>Nut M2.5 (2 pcs)</p>
 <p>Allen Key 2.5 mm (1 pc)</p>	 <p>Allen Key 2 mm (1 pc)</p>	 <p>EK-Plug Out Spludger Tool (1 pc)</p>	 <p>Thermal Grease (1 pc)</p>
<p>EAN: 104549</p>	 <p>Thermal Pad F 1.0 mm (7 pcs)</p>	 <p>Thermal Pad F 2.0 mm (2 pcs)</p>	 <p>Thermal Pad G 2.0 mm (2 pcs)</p>

WATER BLOCK DIMENSIONS

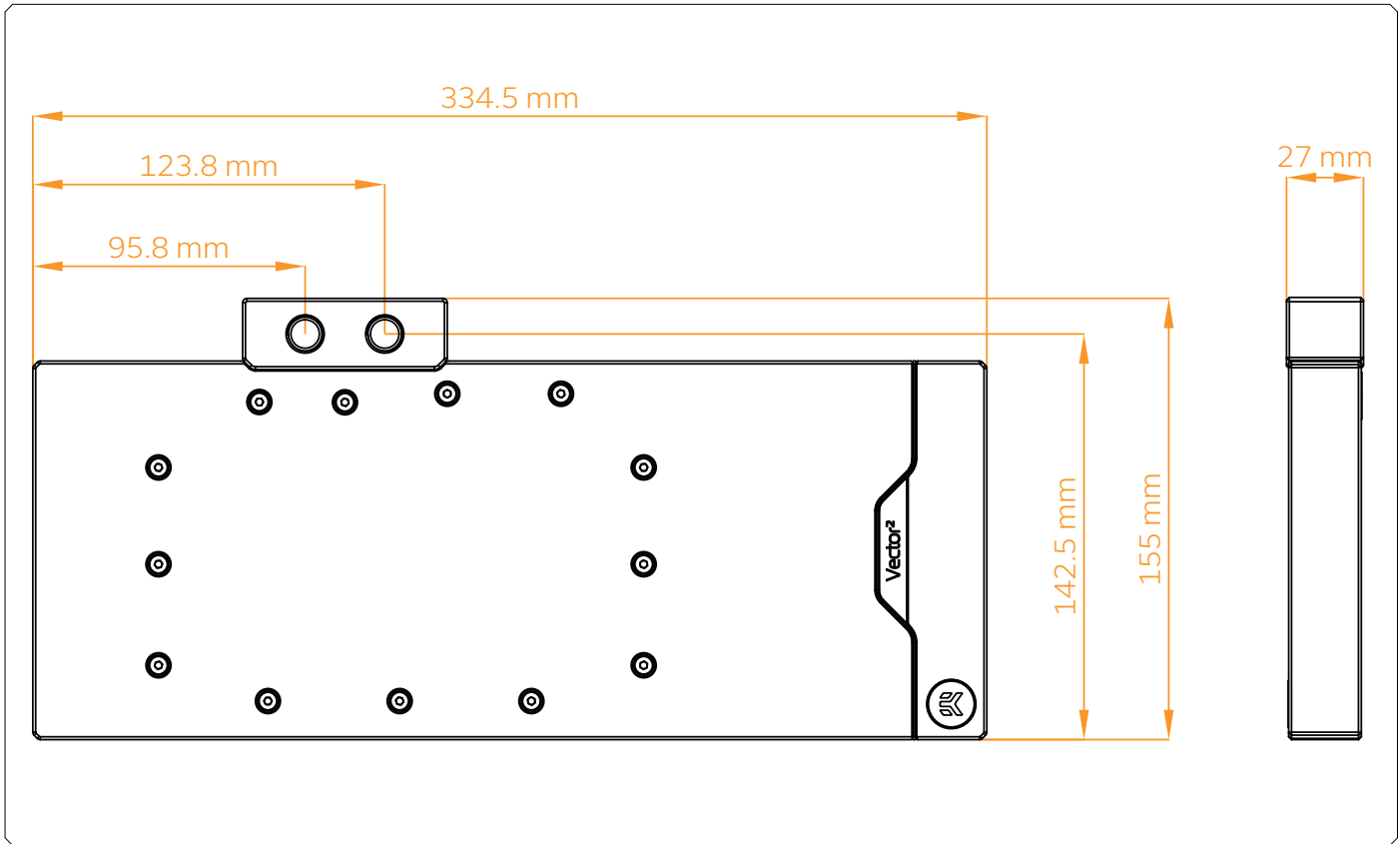

TECHNICAL SPECIFICATIONS AND WATER BLOCK PARTS

NICKEL PLEXI

- Dimensions: (LxHxW): 334.5 x 155 x 27mm
- D-RGB LED count: 18
- D-RGB cable length: 50cm
- D-RGB connector 3-pin 5V digital LED header

Position	EAN	Description	Quantity
1	104465	Coldplate (Nickel)	1
2	103971	Acetal Stand Out	1
3	104471	LED Cover	1
4	100663	EK - Badge	2
5	103964	Mylar sticker	2
6	8208	Screw M3x8 7991DIN	2
7	101556	LED D-RGB strip 500/300mm	1
8	103947	FC Terminal	1
9	104468	Top plate (Plexi)	1
10	104475	Backplate (Bl. elox)	1
11	103942	Terminal Badge	1
12	104216	Disc magnet 3x3	2
13	8311	Screw M4x20 DIN7984	3
14	104106	Terminal OR - 14x1 mm	2
15	103987	Standoff M3.5-M2.5 x 3	7
16	103988	Standoff M4-M2.5 x 3mm	4
17	103986	Standoff M3.5-M2.5 x 11.3mm	4
18	104187	Screw M2.5x8 AX1	7
19	104188	Standoff fi 4.5/2.5	7
20	9024	Screw M4x10 DIN7984	13
21	103962	Plexi insert	1
22	104484	Main O-ring 162x2	1
23	104902	PCB cardboard	1

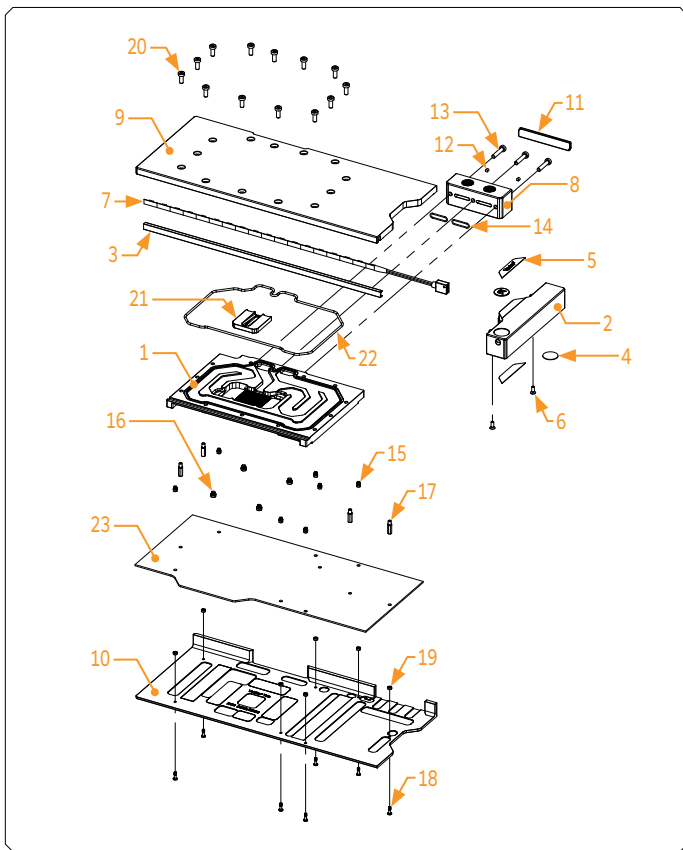

NICKEL ACETAL

- Dimensions: (LxHxW): 334.5 x 155 x 27mm
- D-RGB LED count: 38
- D-RGB cable length: 50cm
- D-RGB connector 3-pin 5V digital LED header

Position	EAN	Description	Quantity
1	104465	Coldplate (Nickel)	1
2	103974	Acetal Stand out	1
3	100663	EK - Badge	2
4	104211	Mylar sticker	2
5	8202	Screw M3x12 DIN7991	2
6	103947	FC Terminal	1
7	103968	Light guide	1
8	104469	Acetal top plate	1
9	104475	Backplate (Bl.elox)	1
10	103942	Terminal Badge	1
11	104216	Disc magnet 3x3	2
12	8311	Screw M4x20 DIN7984	3
13	104106	Terminal OR - 14x1 mm	2
14	103987	Standoff M3.5-M2.5 x 3	7
15	103988	Standoff M4-M2.5 x 3mm	4
16	103986	Standoff M3.5-M2.5 x 11.3mm	4
17	104187	Screw M2.5x8 AX1	7
18	104188	Standoff fi 4.5/2.5	7
19	9024	Screw M4x10 DIN7984	13
20	103962	Plexi insert	1
21	104296	LED D-RGB Dense Strip Double - 500/130mm	1
22	104484	Main O-ring 162 x 2 mm	1
23	104902	PCB cardboard	1

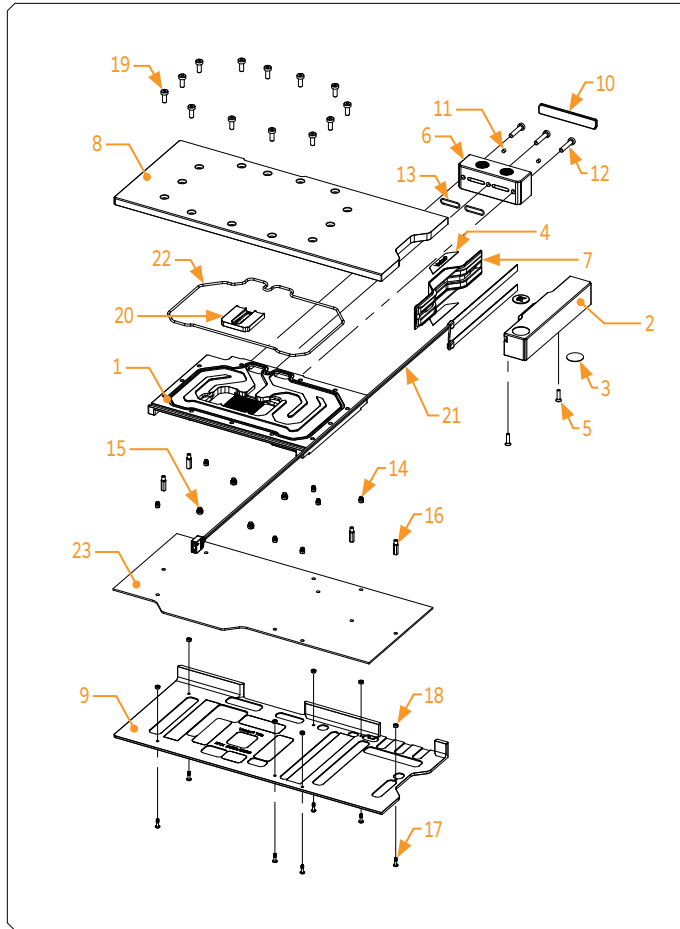

PREPARING THE GRAPHICS CARD

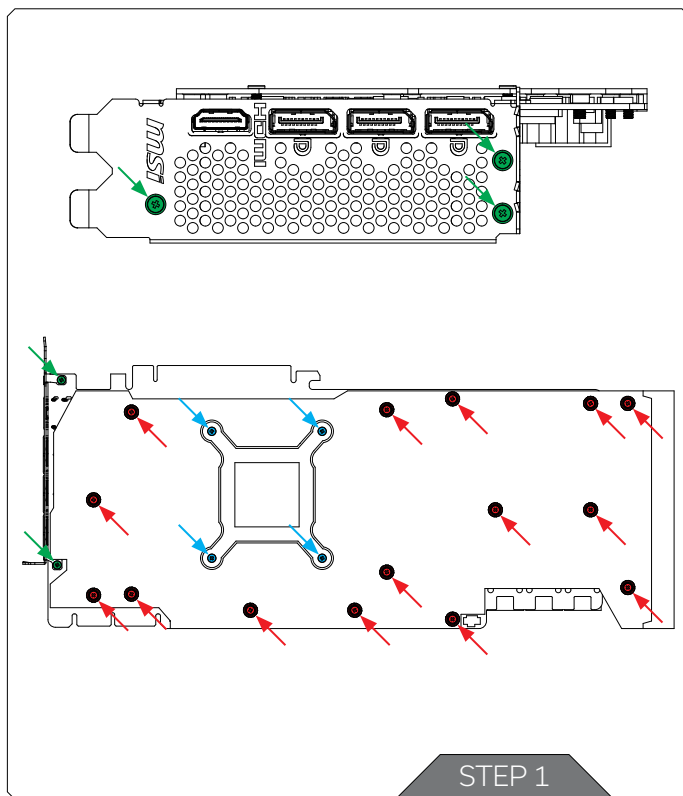

OPTION 1: USING THE MSI GEFORCE 3080/90 SUPRIM X

For this Step, you will need:

Phillips Head Screwdriver

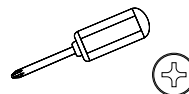

STEP 1

REMOVING THE STOCK COOLER AND BACKPLATE

Place your graphics card on the flat surface and carefully remove the stock cooler. Do not forget to unplug all the LED and fan connectors. Pay attention to the following steps in order to install the EK-Quantum Vector² Trio RTX 3080/90 D-RGB water block on the graphics card.

Use the Phillips head screwdriver to remove the five (5) green marked screws from the GPU bracket side.

Then remove the fifteen (15) red marked screws with Phillips head screwdriver and carefully detach the stock backplate from the PCB. After removing the stock backplate remove four (4) blue marked screws on retention bracket and you can move to step 2 of the process.



Always remove the stock cooler slowly - it might be firmly glued to the PCB with thermal pads.

OPTION 2: USING THE MSI GEFORCE RTX 3080/90 GAMING X TRIO

STEP 1

Place your graphics card on the flat surface and carefully remove the stock cooler. Do not forget to unplug all the LED and fan connectors. Pay attention to the following steps in order to install the EK-Quantum Vector² Trio RTX 3080/90 D-RGB water block on the graphics card.

Use the Phillips head screwdriver to remove the three (3) green marked screws from the GPU bracket side.

Then remove the fifteen (15) red marked screws with Phillips head screwdriver and carefully detach the stock backplate from the PCB. After removing the stock backplate remove four (4) blue marked screws on retention bracket and you can move to step 2 of the process.



Always remove the stock cooler slowly - it might be firmly glued to the PCB with thermal pads.

For this Step, you will need:

Phillips Head Screwdriver

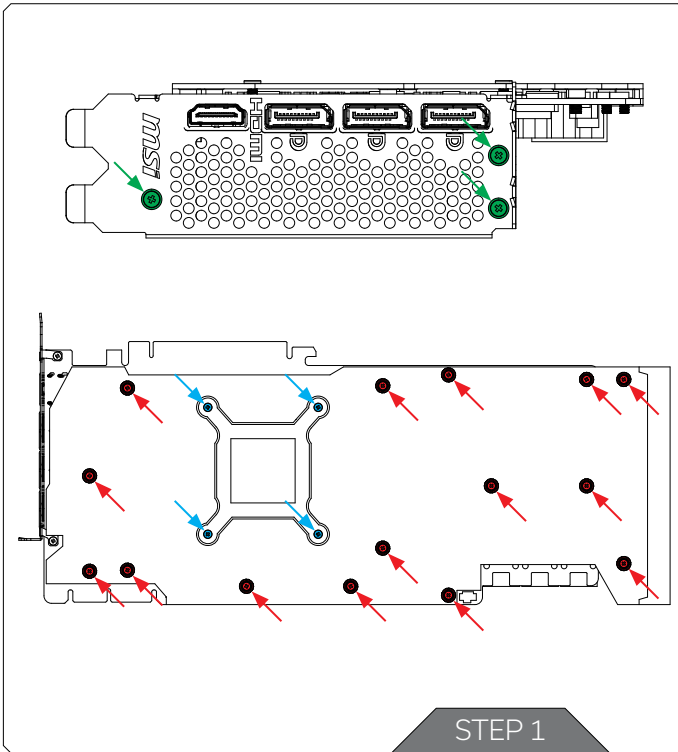
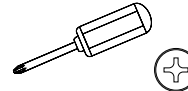

PREPARING THE WATER BLOCK FOR INSTALLATION

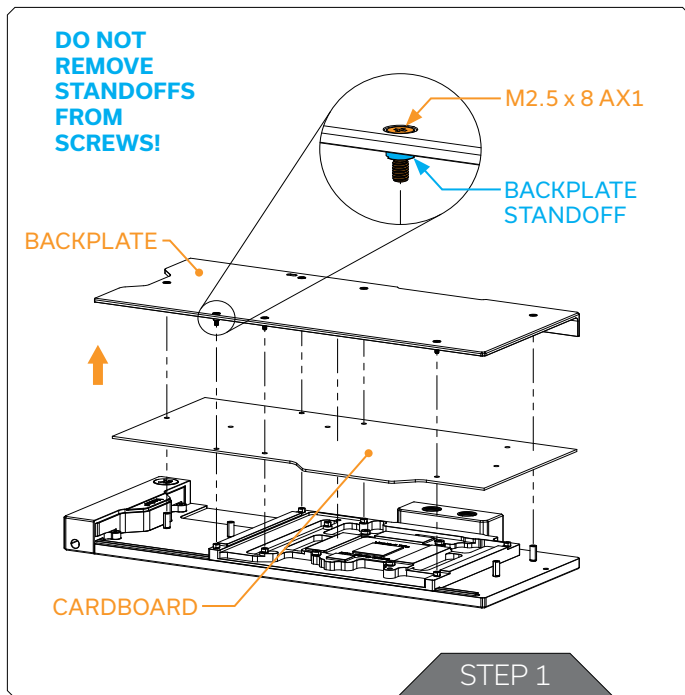

STEP 1

Unscrew seven (7) Screws AX1 M2.5x8 as shown in the image. Remove the backplate together with seven (7) Screws AX1 M2.5x8 and backplate standoffs. Standoffs must stay on Screws AX1 M2.5x8. Remove cardboard. Save the backplate set for later steps.



Do not remove standoffs from screws! In case the standoff detaches from the screw, replace it with a spare one. When replacing the standoff make sure that you screw it on the AX1 M2.5x8 screw. Do not push the standoff onto the screw AX1 M2.5x8!

For this step, you will need:

Phillips Head Screwdriver

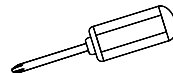

CUTTING AND PLACING THERMAL PADS

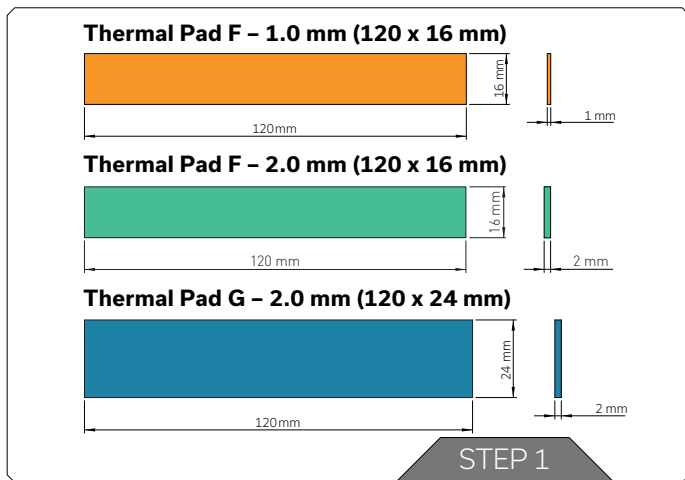

STEP 1

Your EK-Quantum Vector² Trio RTX 3080/90 D-RGB block comes with Thermal Pads that have to be cut into smaller pieces to cover all the VRM components. EK made sure to provide you with more than an adequate quantity of Thermal Pads to complete this Step.



CAUTION: You must remove the protective foil from both sides of the thermal pad before installation.

Replacement thermal pads:

Thermal Pad F 1.0mm - (120 x 16mm) EAN: 3830046996732

Thermal Pad F 2.0mm - (120 x 16mm) EAN: 3830046996756

Thermal Pad G 2.0mm - (120 x 24mm) EAN: 3830046996794

For this step, you will need:

Scissors

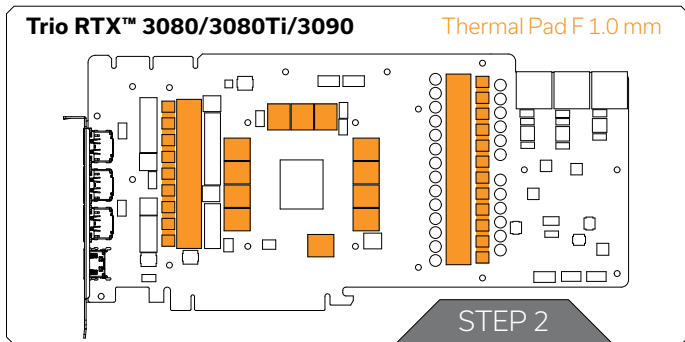
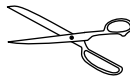

STEP 2

The cardboard is printed in scale 1:1. Cut Thermal Pads to the size printed on the cardboard. Once cut to the size, Thermal Pads should be placed on the block, as shown in the picture.



Before attaching the PCB to the Water Block, make sure all the Thermal Pads are placed correctly!

APPLYING THERMAL COMPOUND

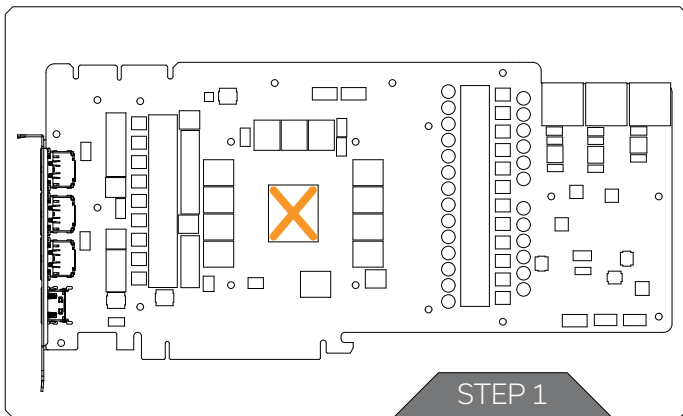

STEP 1

Apply the enclosed EK-TIM Ectotherm thermal grease (thermal compound) on the GPU heat spreader - IHS - as shown in the image. The layer of the thermal compound must be thin and even over the entire surface of the IHS.



The excessive or uneven application of thermal grease may lead to poor performance!

For this Step, you will need:

Thermal Grease

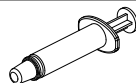

ATTACHING THE WATER BLOCK (Option 1: MSI GEFORCE 3080/3080Ti/3090 SUPRIM X)

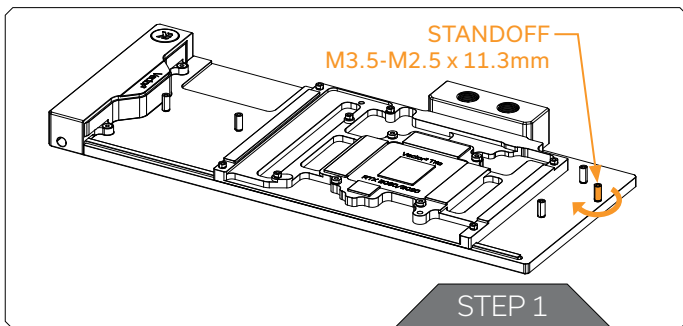

STEP 1

From the mounting mechanism take the additional standoff M3.5-M2.5 x 11.3mm and attach it to the water block using the 4mm hex bit.

For this Step, you will need:

STANDOFF M3.5-M2.5 x 11.3mm (1x)



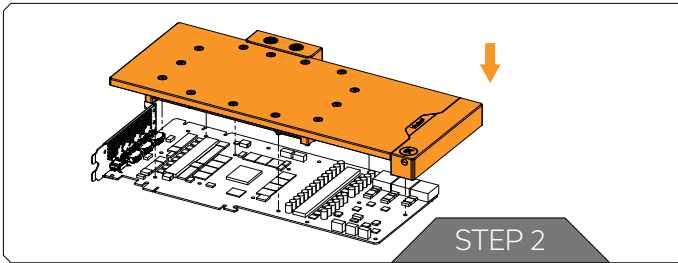

STEP 2

Carefully position the water block with preinstalled standoffs on the graphics card. During this process, make sure you have aligned mounting holes of the PCB with holes of the water block.

Pay attention not to use too much force when pressing the block down to the PCB since chip dies are prone to cracking.

Before attaching the PCB to the Water Block, make sure all the Thermal Pads are placed correctly!

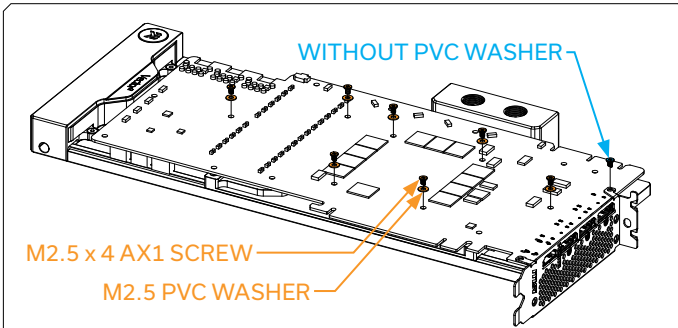

STEP 3

Use eight (8) M2.5x4 AX1 Screws and seven (7) PVC washers to tighten the PCB on the water block. Tighten the screws evenly using the Phillips-head screwdriver. EK recommends you start tightening the screws around the GPU core first, and then continuing outward to prevent damage to the GPU.

For this step, you will need:

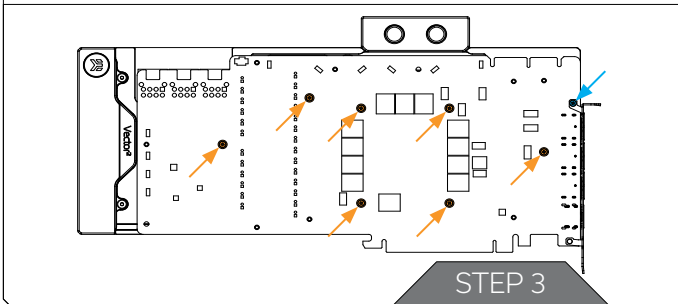
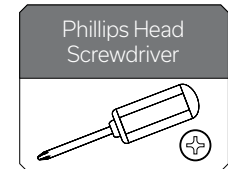
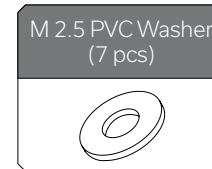
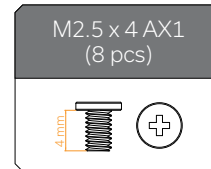

Screws must be present in the places marked on the picture.

ATTACHING THE WATER BLOCK (Option 2: MSI GEFORCE 3080/3080Ti/3090 TRIO)

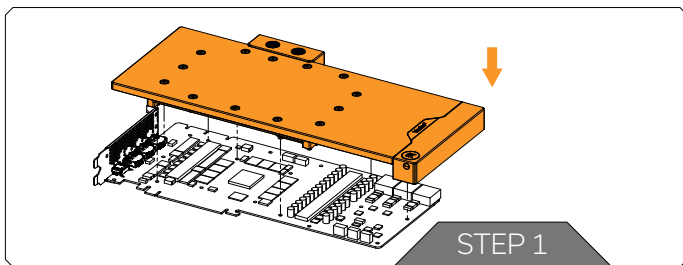

STEP 1

Carefully position the water block with preinstalled standoffs on the graphics card. During this process, make sure you have aligned mounting holes of the PCB with holes of the water block.

Pay attention not to use too much force when pressing the block down to the PCB since chip dies are prone to cracking.

Before attaching the PCB to the Water Block, make sure all the Thermal Pads are placed correctly!

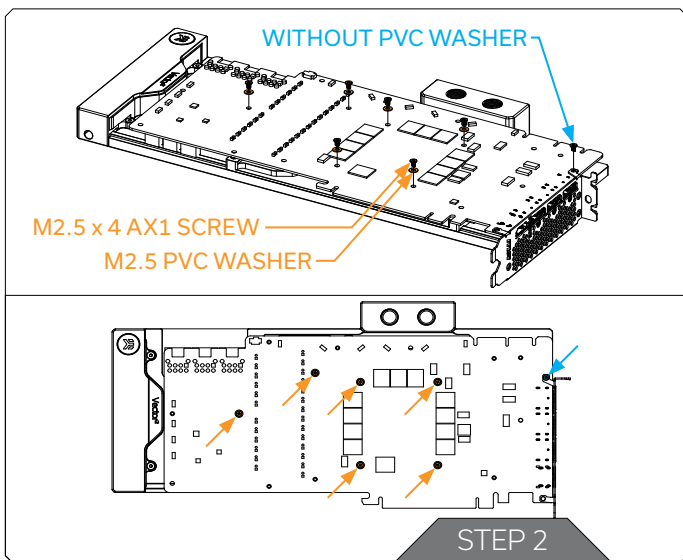

STEP 2

Use seven (7) M2.5x4 AX1 Screws and six (6) PVC washers to tighten the PCB on the water block. Tighten the screws evenly using the Phillips-head screwdriver. EK recommends you start tightening the screws around the GPU core first, and then continuing outward to prevent damage to the GPU.

For this step, you will need:

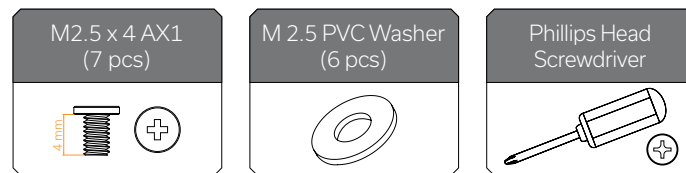

Screws must be present in the places marked on the picture.

PREPARING THE BACKPLATE

Thermal Pad F – 1.0 mm (120 x 16 mm)



Thermal Pad F – 2.0 mm (120 x 16 mm)



Thermal Pad G – 2.0 mm (120 x 24 mm)



STEP 1

STEP 1

After attaching the water block, a few more thermal pads need to be cut into smaller pieces to cover all the necessary components.

EK made sure to provide you with more than an adequate quantity of thermal pads to complete this step.



CAUTION: You must remove the protective foil from both sides of the thermal pad before installation.

Replacement thermal pads:

Thermal Pad F 1.0mm - (120 x 16mm) EAN: 3830046996732

Thermal Pad F 2.0mm - (120 x 16mm) EAN: 3830046996756

Thermal Pad G 2.0mm - (120 x 24mm) EAN: 3830046996794

For this step, you will need:

Scissors

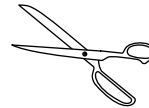

Apply the thermal pads onto the backplate as shown in the image.

- F1** Thermal Pad - 120 x 16 x 1.0 mm
- F2** Thermal Pad - 120 x 16 x 2.0 mm
- G2** Thermal Pad - 120 x 24 x 2.0 mm

3080/ 3080Ti:

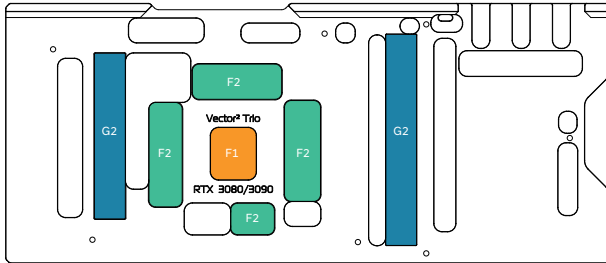

3090:

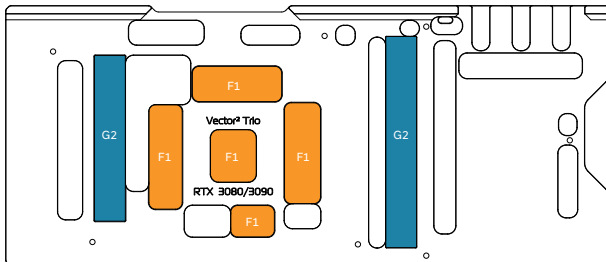

STEP 1

ATTACHING THE BACKPLATE

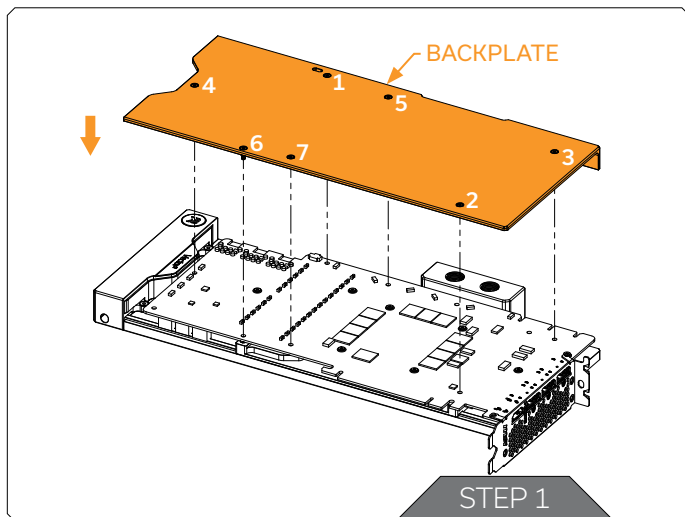

STEP 1

Place the backplate with seven (7) M2.5x8 AX1 Screws and Standoffs onto the PCB. Make sure all the holes are aligned.

Tighten the screws according to the numerical order shown in the image!

Do not use excessive force!

For this step, you will need:

Phillips Head Screwdriver

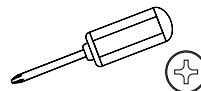

INSERTING THE GRAPHICS CARD INTO THE CHASSIS

Carefully lift your graphics card with the installed water block and insert it into your PC's motherboard PCI Express expansion slot. Please keep in mind that your graphics card is heavier than before it was equipped with the water block.



You need to be very careful when handling the graphics card. Avoid all unnecessary manipulation of the water block assembly that might damage your card or water block.

FITTINGS AND TUBING

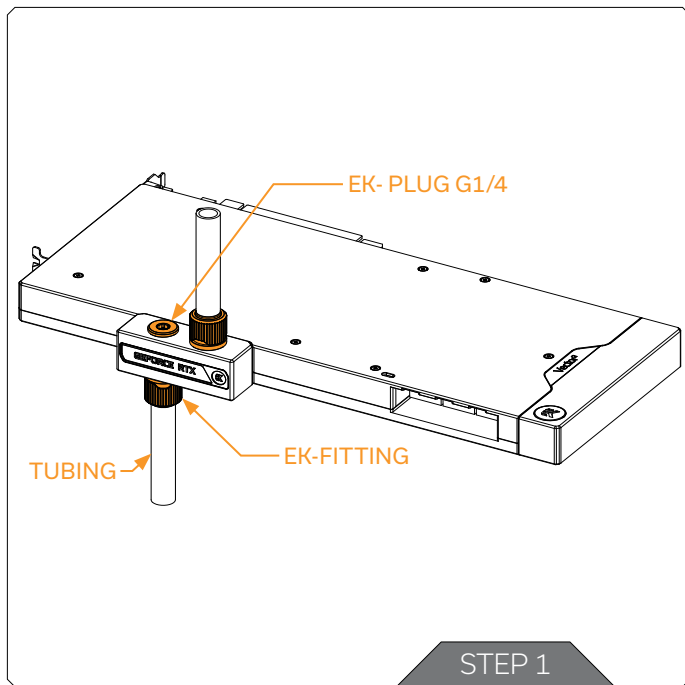

STEP 1

Screw-in two (2) G1/4 threaded male fittings. Attach the liquid cooling tubes and connect the water block to the cooling loop.



Do not forget to plug the remaining two openings using the enclosed EK-Plug G1/4 or its equivalent.

EK recommends using EK fittings with all EK water blocks.



CAUTION: When using connectors other than EK fittings, pay special attention to the length of the fittings' male G1/4" thread - 5mm is the maximum G1/4" thread length allowed!

For this step, you will need:

EK-Loop Multi Allen Key

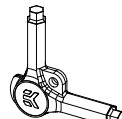

CONNECTING THE D-RGB LED STRIP

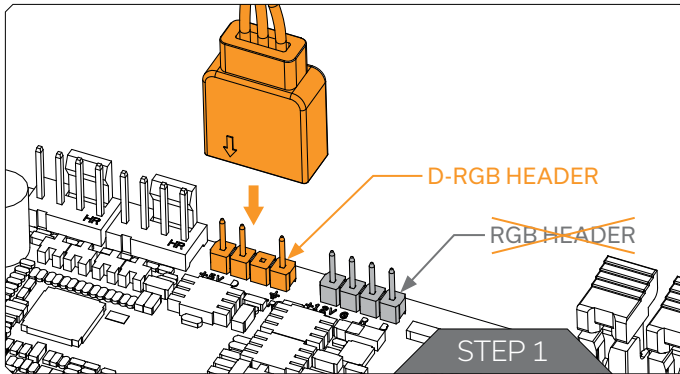

STEP 1

Plug the **3-pin connector** of the distribution plate D-RGB LED light to the **D-RGB HEADER** on the motherboard. The LED will work if the pin layout on the header is as follows: **+5V, Digital, Empty, Ground**.



Incorrect installation or installation to a wrong header can damage the LED strip or the header itself!

TESTING THE LOOP

To make sure the installation of EK components was successful, we recommend you perform a leak test for 24 hours. When your loop is complete and filled with coolant, connect the pump to a PSU outside of your system. Do not connect power to any of the other components. Turn on the PSU and let the pump run continuously. It is normal for the coolant level to drop during this process as air collects in the distribution plate. Inspect all parts of the loop, and in the eventuality that coolant leaks, fix the issue and repeat the testing process. Ensure that all hardware is dry before the system is powered on in order to prevent any damage.

WARRANTY

Our products are warranted against defects of materials and quality for a period of 24 months, starting with the date of delivery to the end-user. During this period, products will be repaired or have parts replaced at our discretion, provided that 1) the product is returned to the agent from whom it was purchased; 2) the product has been purchased by the end-user and has not been used for commercial purposes; 3) the product has not been misused, handled carelessly, or used in a manner other than the way described in the instructions manual. This warranty does not confer rights other than those expressly set out above and does not cover any claims for consequential loss or damage. This warranty is offered as an extra benefit and does not affect your statutory rights as a consumer. This warranty is voided if the product comes in contact with aggressive UV additives or other improper liquids. EK water blocks are sealed with a warranty-voiding circular label, proving the water block has withstood a pressure leak test. Removing the label will void the leak-free guarantee, but not the guarantee on the product itself. Any other RMA issues can be reported to EK Customer Support at www.ekwb.com/support for further analysis.

SUPPORT AND SERVICE

In case you need assistance or wish to order spare parts or a new mounting mechanism, please contact:

<https://www.ekwb.com/customer-support/>

For spare parts orders, refer to the page with "TECHNICAL SPECIFICATIONS AND WATER BLOCK PARTS" where you can find the EAN number of each part you might need.

Include the EAN number with quantity in your request. Mounting Mechanism EAN can be found under "BOX CONTENTS"

Thermal pads are readily available in the EK shop

SOCIAL MEDIA

 EKWaterBlocks

 @EKWaterBlocks

 ekwaterblocks

 EKWBofficial

 ekwaterblocks

