

This product is intended for installation only by expert users. Please consult with a qualified technician for installation. Improper installation may result in damage to your equipment. EK Water Blocks assumes no liability whatsoever, expressed or implied, for the use of these products, nor their installation. The following instructions are subject to change without notice. Please visit our web site at www.ekwb.com for updates. Before installation of this product please read important notice, disclosure and warranty conditions printed on the back of the box.

Before you start using this product please follow these basic guidelines:

1. Please carefully read the manual before through before beginning with the installation process!
2. Please remove your motherboard from the computer to assure safest mounting process in order to prevent any possible damages to your CPU and/or motherboard's circuit board (PCB).
3. The EK High Flow and EK-PSC type fittings require only a small amount of force to screw them firmly in place since the liquid seal is ensured by the rubber o-ring gaskets.
4. The use of corrosion inhibiting coolants is always recommended for any liquid cooling system.

STEP 1: GENERAL INFORMATION. Sample picture of AMD Radeon HD 7970 graphics card (PCB 109-C38637-00)



STEP 2: PREPARING YOUR GRAPHIC CARD.

1. REMOVING STOCK COOLER: Remove encircled screw on the bracket (required only on certain models):



STEP 2 cont.: PREPARING YOUR GRAPHIC CARD

1 cont.. REMOVING STOCK COOLER. Remove all encircled screws. All heat sink assembly should be removed. There are 16 screws on the back of the graphic card.

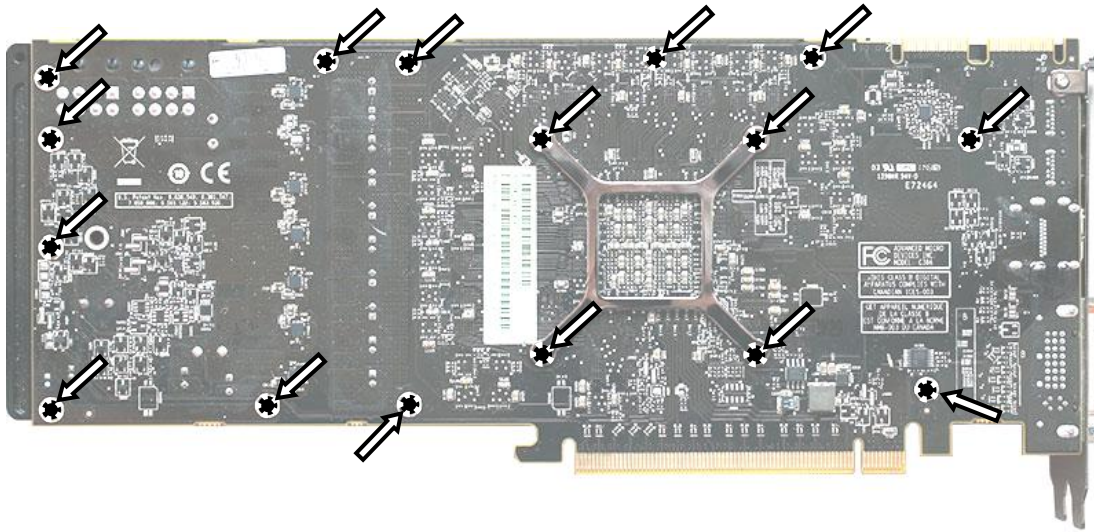

2. CLEANING THE PCB. Carefully detach the original stock cooler after removing all screws securing it to the board. Wipe off the remains (by using non-abrasive cloth or *qtip*, as shown on sample photo) of the original thermal compound until the components and circuit board are completely clean. EKWB recommends the use of denatured alcohol for removing TIM leftovers.



3. APPLYING THERMAL COMPOUND. Apply thermal compound: lightly coat AMD GPU chip with for example Arctic Cooling MX-2™ or MX-4™ thermal grease. EKWB recommends to apply thermal grease in cross form for best performance (see sample picture).

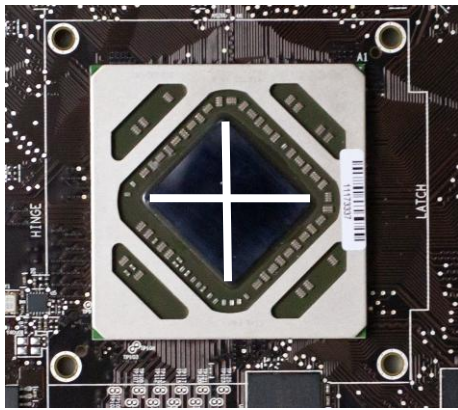

4. CUTTING THERMAL PADS. Your block comes with thermal pads, some of which are already pre-cut. Others have to be cut to smaller chunks in order to cover all the VRM components such as MOSFETs and drivers. PLEASE REMOVE THE PROTECTIVE FOIL FROM BOTH SIDES OF THE THERMAL PADS PRIOR TO INSTALLATION.

Replacement thermal pads: 1x Thermal Pad B – 0.5mm (75x50mm), Thermal Pad A – 1mm (100x16mm).

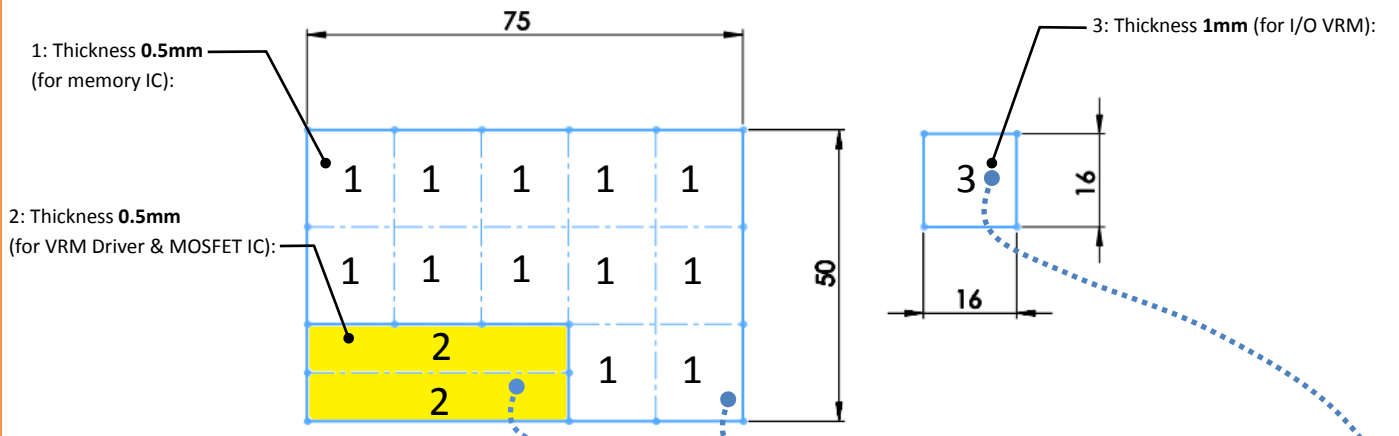

STEP 3: INSTALLING WATER BLOCK

1. PLACING THERMAL PADS ON PCB. Place thermal pads on chips so that numbers on chips match size of thermal pads. EKWB made sure users have more than enough pads to cover all surfaces that need to be covered to make block fully functional). EKWB recommends using small drops of electrically non-conductive (for example: Arctic Cooling MX-2™, MX-4™ or GELID GC-Extreme™) thermal grease on each phase regulator (that is being covered with thermal pad) in order to even further improve the thermal performance of the EK-FC7970 CSQ series water block.

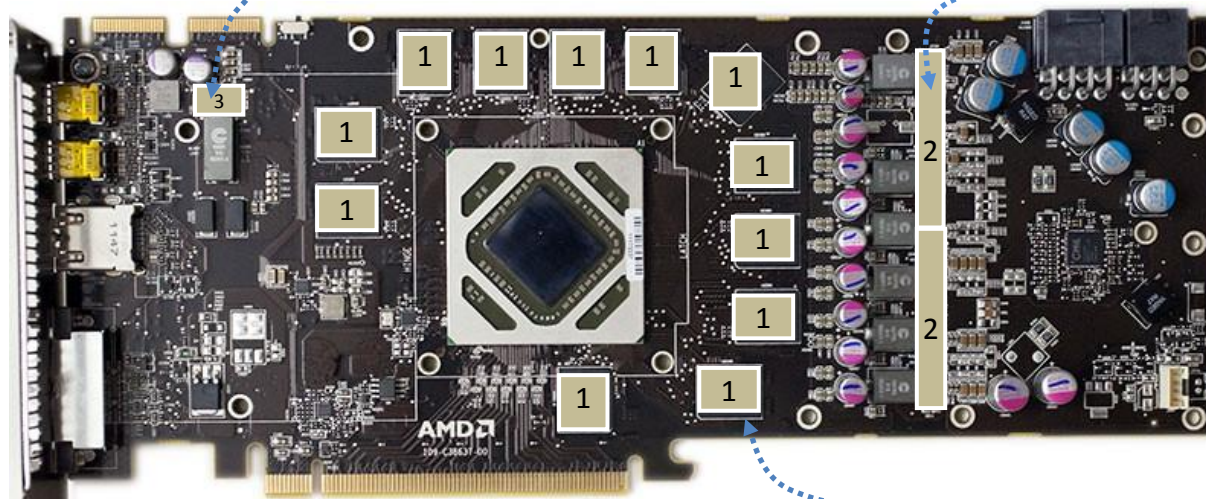

2. PLACING BLOCK TO GRAPHIC CARD. Carefully position the water block with preinstalled 2.5mm standoffs on to the graphics card. During this process please make sure you align mounting holes on PCB with holes on the water block. Also pay attention not to use too much force by pressing block down to PCB. Chip dies are prone to cracking.

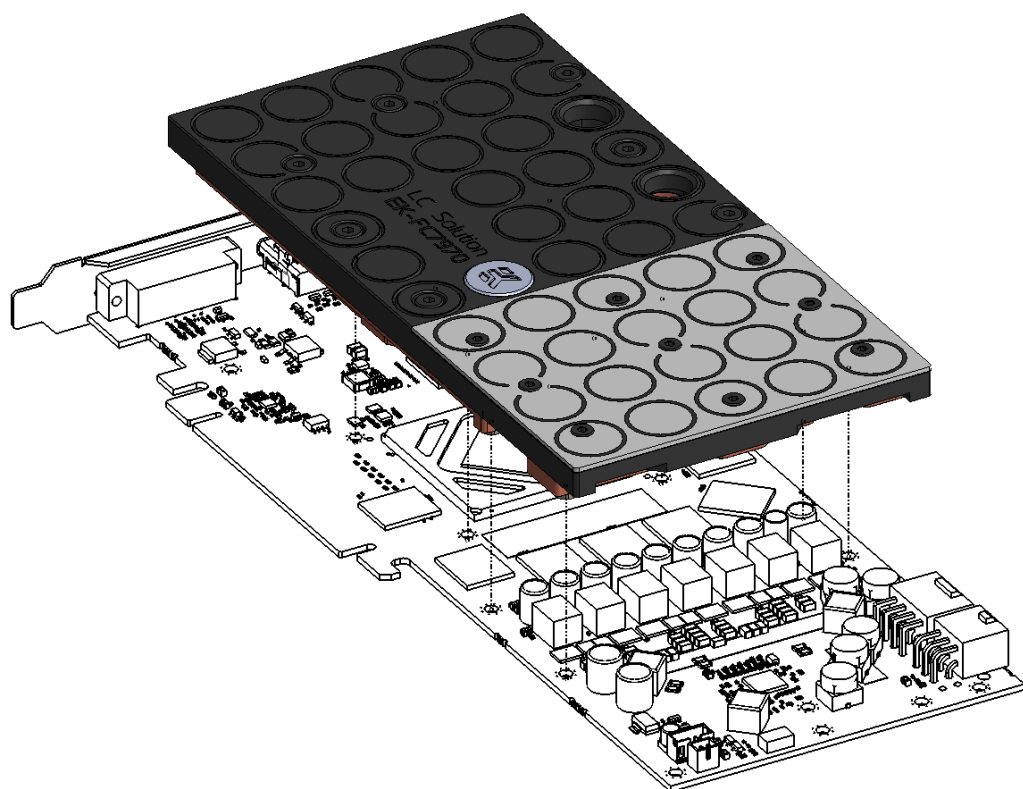

3. ATTACHING BLOCK TO GRAPHIC CARD. By using Philips screwdriver screw in enclosed M3x4 screws. EKWB recommends start screwing the screws around the GPU core and continue outwards. Always use a PVC washer underneath each and every screw!

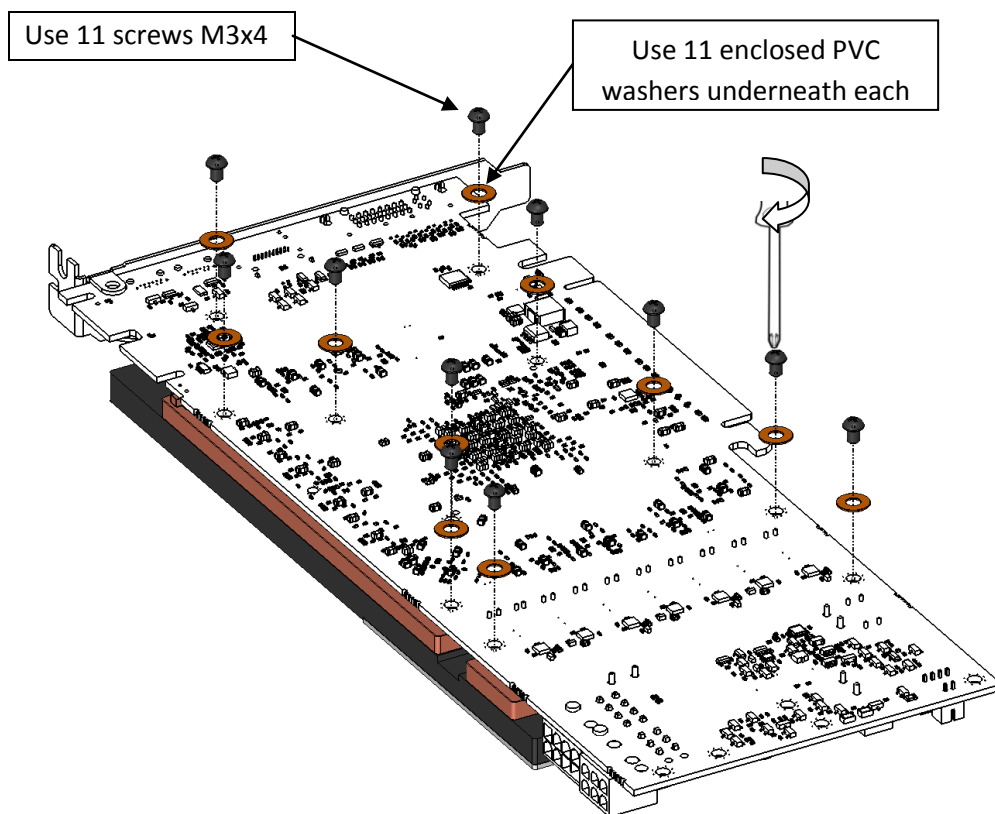

STEP 4: CHECKING FOR CONTACTS

Temporarily remove the water block to check for uniform surface contact between the block and the components, pay special attention to the VRM section of the graphics card. Check whether the water block makes contact with the VRM. Then repeat sub-steps in previous section to re-attach the block. **In case you fail to obtain good contact, please check again your thermal pad thickness or contact our support service.**

STEP 7: INSERTING CARD IN YOUR PC CASE

Carefully lift your graphics card with installed block and insert it in your PC's motherboard PCI-express expansion slot. Please bear in mind that your graphics card is probably heavier than when it was equipped with original heat sink fan assembly. One needs to be very careful when handling the graphics card. Avoid all un-needed manipulation of the VGA/water block assembly that might damage your card or water block during final installation.

STEP 5: FITTING POSITIONING

Screw in the fittings in the G1/4 threaded openings on plastic top of the water block. EKWB recommends using EK-PSC fittings with the EK-FC7970 CSQ series water blocks. To ensure that the tubes are securely attached to the barb/fittings, please use hose clamps or an appropriate substitute. You can use any opening as an inlet/outlet port.

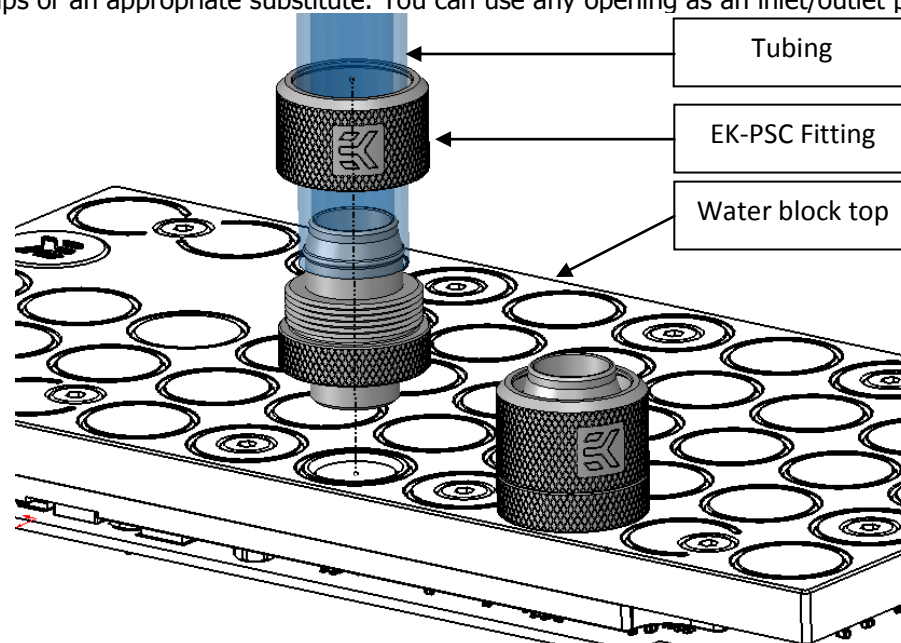

INSTALLING EK-FC LINK:

Alternatively you can install the enclosed EK-FC Link which allows installation of both EK-FC Bridge system as well as the use of G1/4 threaded fittings.

Please remove the middle M4x8 DIN7984 screw, install the EK-FC Link together with OR 14x1.5mm gaskets and secure it with enclosed M4x25 DIN7985 screw. Use enclosed 2.5mm Allen (hex) key!

Once installed you can install two (preferably angled) G1/4 threaded fittings or any EK-FC Bridge CSQ series interconnect (*serial or parallel*)

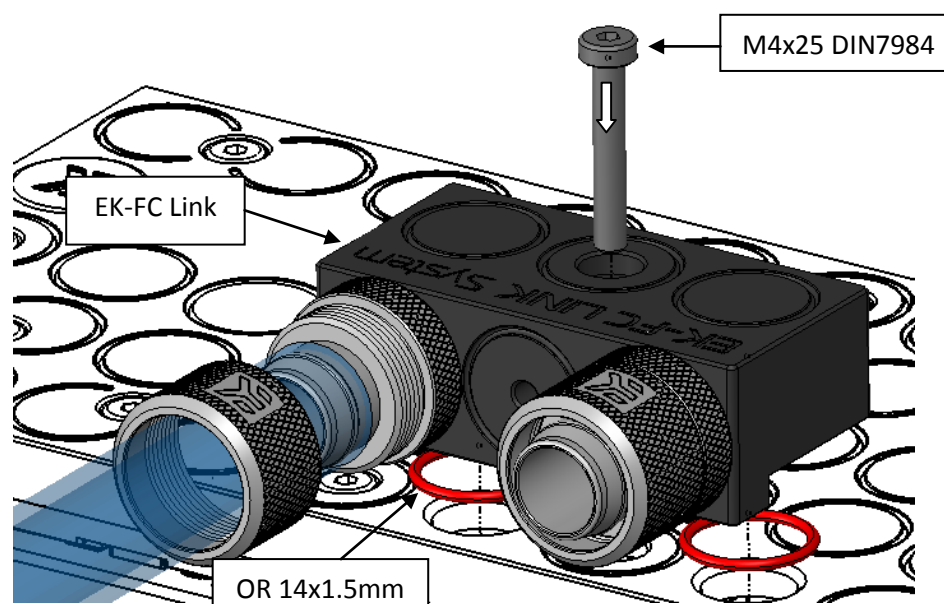

REQUIRED TOOLS AND MOUNTING SCREWS:

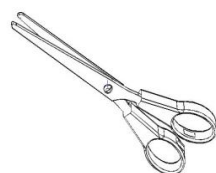

scissors



philips screwdriver

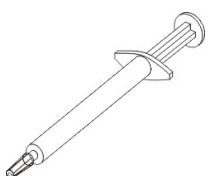

thermal grease