

# EK-Quantum Vector Master RX 6800XT/6900XT Backplate

BACKPLATE

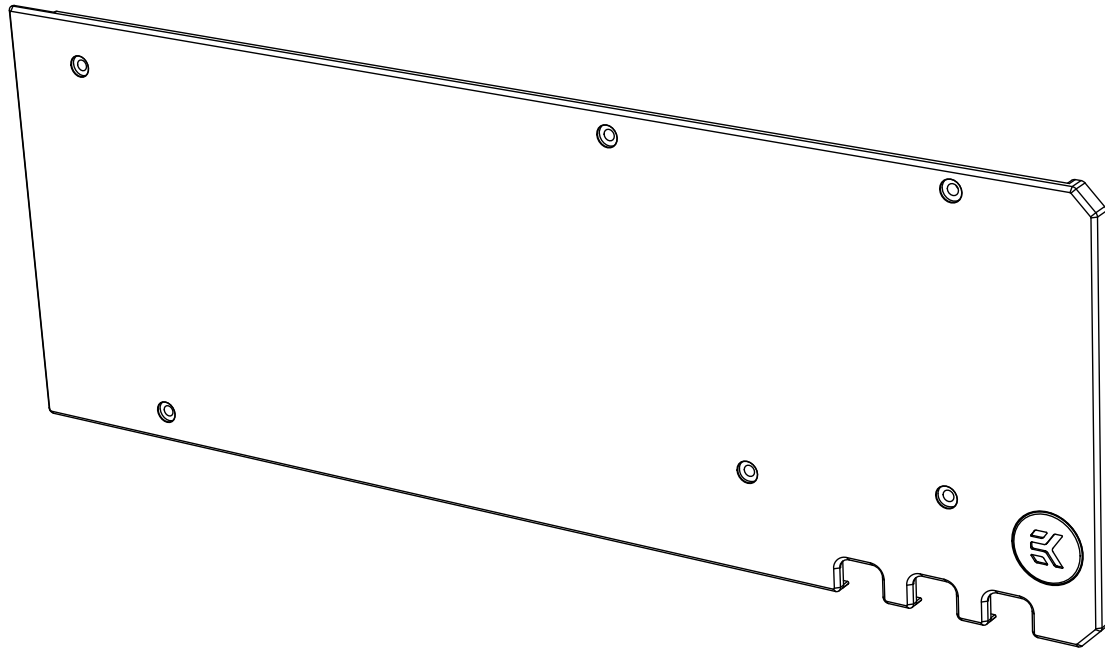

This product is intended for installation only by expert users. Please consult with a qualified technician for installation. Improper installation may result in damage to your equipment. EK Water Blocks assumes no liability whatsoever, expressed or implied, for the use of these products, nor their installation. The following instructions are subject to change without notice. Please visit our web site at [www.ekwb.com](http://www.ekwb.com) for updates.

Before you start using this product, please follow these basic guidelines:

**Please carefully read the manual thoroughly before beginning with the installation process!**

**Please remove your graphics card from the computer to assure safest mounting process in order to prevent any possible damages to your GPU and/or graphics card circuit board (PCB).**

# TABLE OF CONTENTS

<b>BOX CONTENTS</b> .....	<b>4</b>
<b>BACKPLATE DIMENSIONS</b> .....	<b>5</b>
<b>INSTALLING THE BACKPLATE</b> .....	<b>6</b>
PREPARING YOUR GRAPHIC CARD.....	6
CUTTING AND PLACING THERMAL PADS.....	6
ATTACHING THE BACKPLATE.....	7
<b>IMPORTANT DISCLOSURES</b> .....	<b>8</b>
IMPORTANT NOTICE.....	8
WARRANTY.....	8
<b>SUPPORT AND SERVICE</b> .....	<b>9</b>
<b>SOCIAL MEDIA</b> .....	<b>9</b>

# BOX CONTENTS

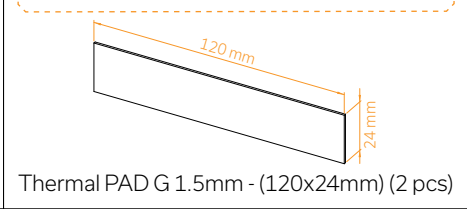
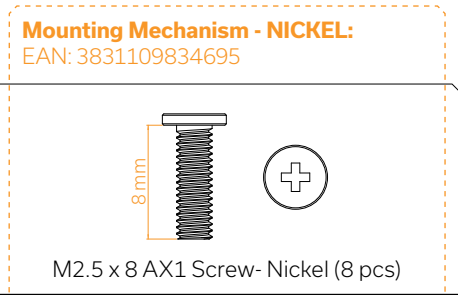
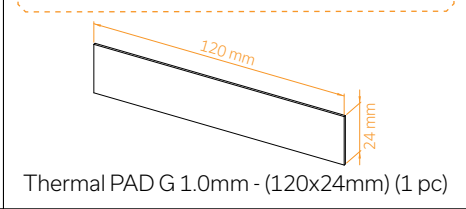
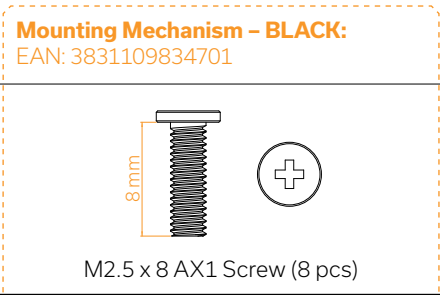
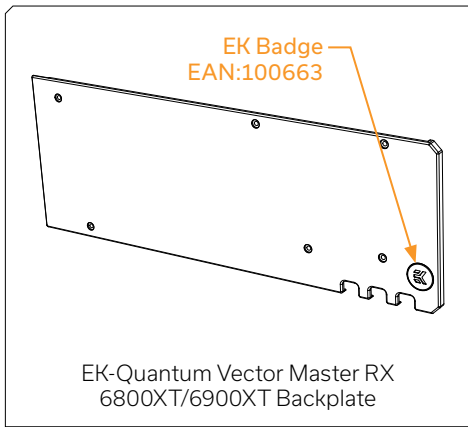

# BACKPLATE DIMENSIONS

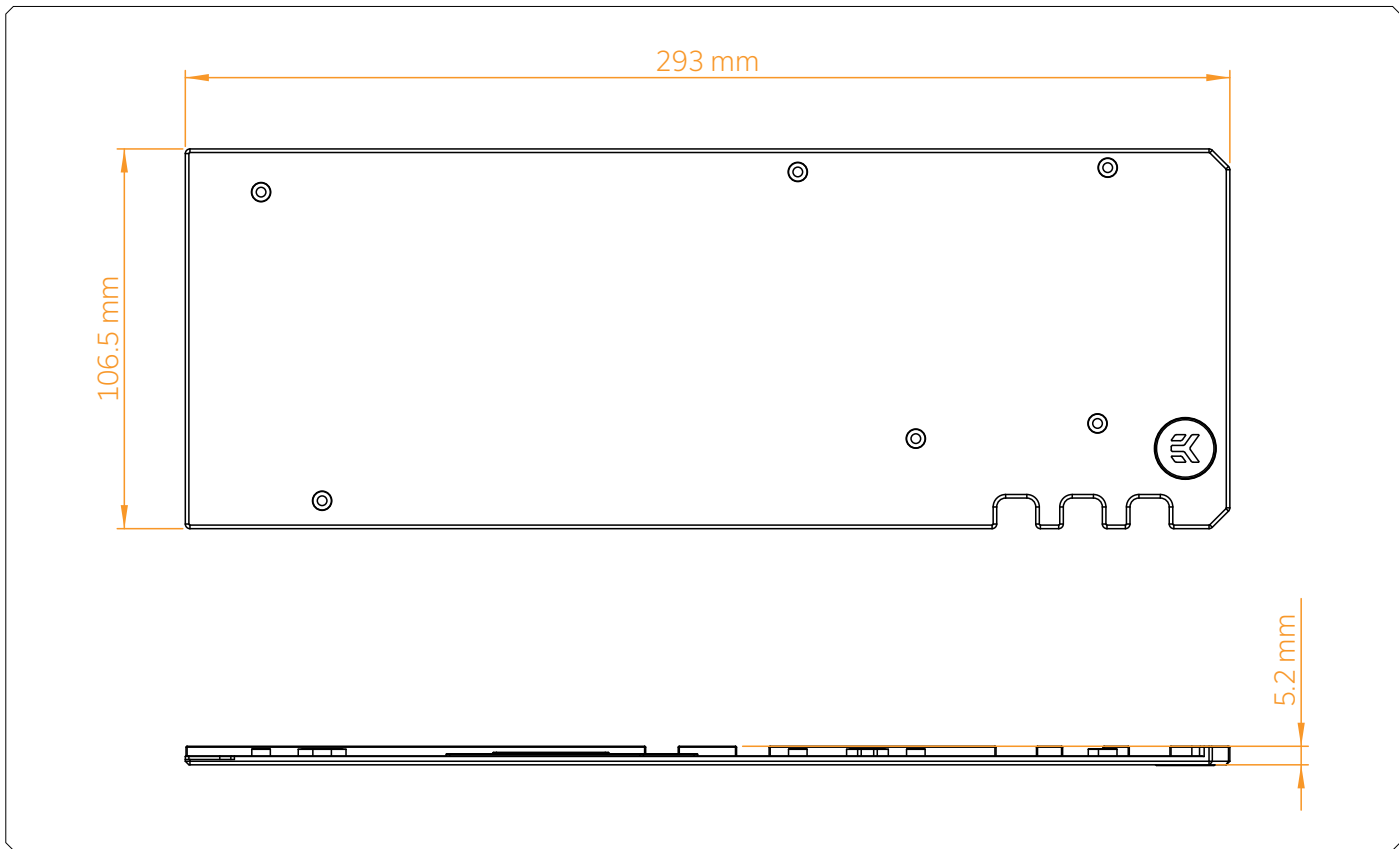

## INSTALLING THE BACKPLATE

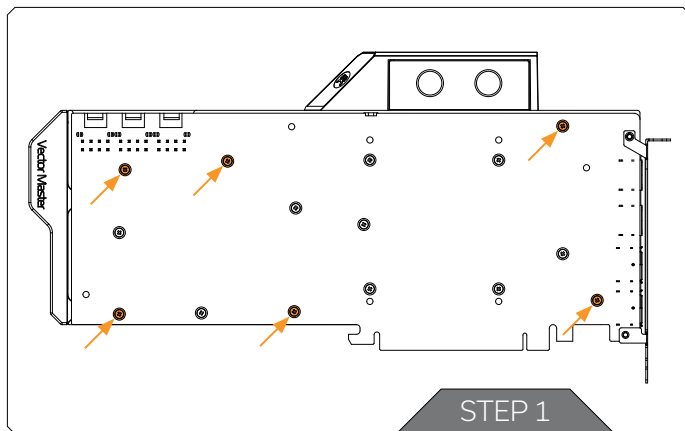

### STEP 1

#### PREPARING YOUR GRAPHIC CARD

First complete the installation of your EK-Quantum Vector Master RX 6800/6900 water block according to its installation manual.

If water block is already installed, remove the six (6) AX1 screws and their PVC washers. Mentioned screws and washers are marked in the image.

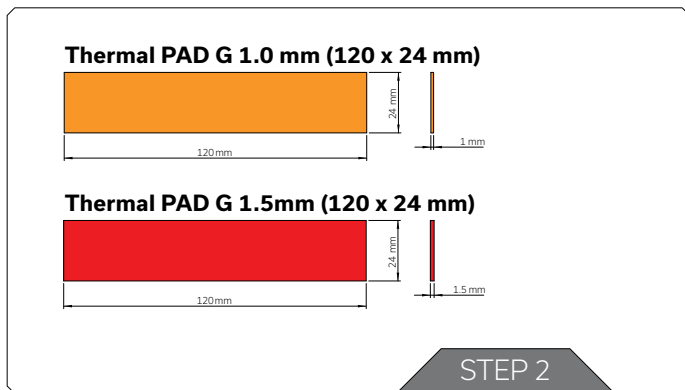

### STEP 2

#### CUTTING AND PLACING THERMAL PADS

Your backplate is supplied with thermal pads that needs to be cut into smaller pieces in order to cover all VRM components. EK made sure to provide customers with more than adequate quantity of thermal pads to complete this step.



PLEASE REMOVE THE PROTECTIVE FOIL FROM BOTH SIDES OF THE THERMAL PADS PRIOR TO INSTALLATION.

Replacement thermal pads:

2x Thermal PAD G 1.5 mm - (120 x 24 mm) - EAN: 3830046996787

1x Thermal PAD G 1.0 mm - (120 x 24 mm) - EAN: 3830046996770

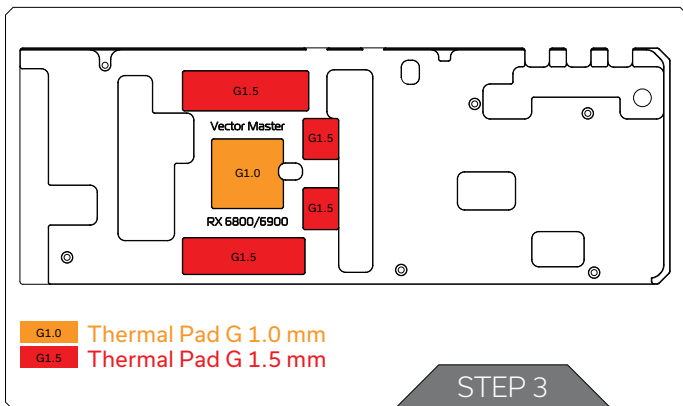

### STEP 3

Once cut to size thermal pads should be applied to the backplate as shown in the image.

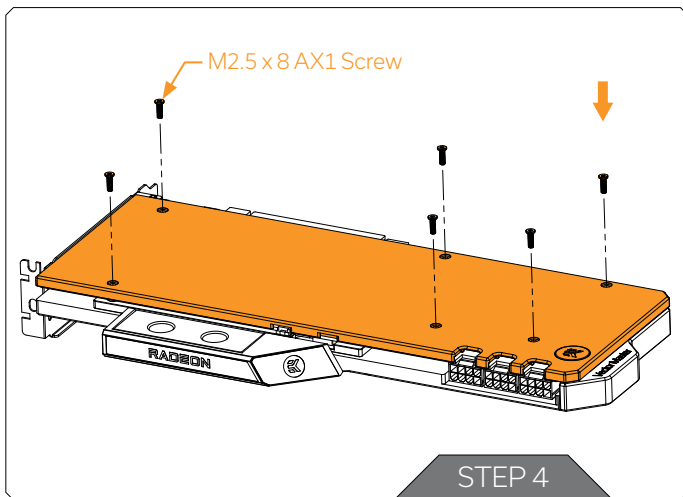

### STEP 4

#### ATTACHING THE BACKPLATE

Place the backplate on to the PCB aligning all of the holes. Position an M2.5 x 8 AX1 screw in each of the (6) mounting holes marked below and then tighten them evenly using a Phillips head screwdriver. **Do not use excessive force!**

For this Step, you will need:

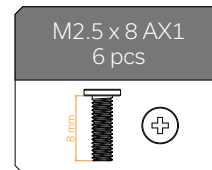
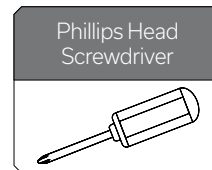

## IMPORTANT DISCLOSURES

### IMPORTANT NOTICE

Once the installation is completed, it is a recommended practice to test the cooling circuit for leaks prior to powering up the computer. We recommend a 24 hour leak test prior to powering up the computer. Do not test the water block using city water pressure. This will rupture the top of the housing and render the block unusable (and will void your warranty). While all efforts have been made to provide the most comprehensive tutorial possible, EK Water Blocks assumes no liability expressed or implied for any consequential damage(s) occurring to your equipment as a result of using EK Water Blocks cooling products, either due to errors or omissions on our part in the above instructions, or due to failure or defect in the EK Water Blocks cooling products.

### WARRANTY

Our products are warranted against defects in materials or workmanship for a period of 24 months beginning from the date of delivery to the final user. During this period, products will be repaired or have parts replaced at our discretion provided that: (I) the product is returned to the agent from whom it was purchased; (II) the product has been purchased by an end user and has not used for commercial purposes; (III) the product has not been misused, handled carelessly, or used in a manner other than in accordance with the instructions provided describing its installation and proper use. This warranty does not confer rights other than those expressly set out above and does not cover any claims for consequential loss or damage. This warranty is offered as an extra benefit and does not affect your statutory rights as a consumer. This warranty is voided if the product comes in contact with aggressive UV additives or other improper liquids. EK blocks are sealed with warranty void circular label, which proves that the block has withstood a pressure leak test. Removing it will void leak-free guarantee and not the guarantee on the product itself. Any other RMA issues can be reported to EK Support at [www.ekwb.com/support](http://www.ekwb.com/support) for further analysis.



## SUPPORT AND SERVICE

In case you need assistance or wish to order spare parts or a new mounting mechanism, please contact:

**<https://www.ekwb.com/customer-support/>**

For spare parts orders, refer to the page with "BOX CONTENTS" where you can find the EAN number of each part you might need.

Include the EAN number with quantity in your request. Mounting Mechanism EAN can be found under "BOX CONTENTS"

Thermal pads are readily available in the EK shop

## SOCIAL MEDIA

 EKWaterBlocks

 @EKWaterBlocks

 ekwaterblocks

 EKWBofficial

 ekwaterblocks

