

# EK-Quantum Vector TUF RX 6800/6900

GPU WATER BLOCK

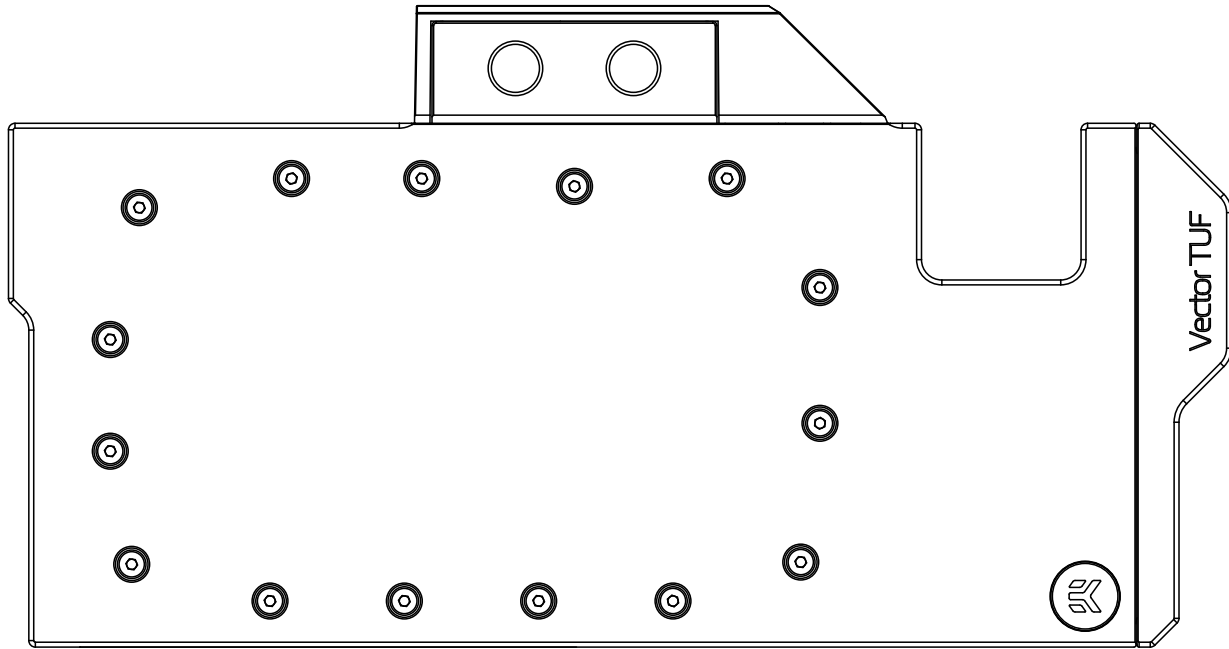

Before you start using this product, please follow these basic guidelines:

**Carefully read the manual before beginning with the installation process.**

**Remove your graphics card from the computer for the safest mounting process to prevent any possible damage to your GPU or its circuit board (PCB).**

**EK Fittings require only a small amount of force to screw them firmly in place since the liquid seal is ensured with the rubber O-ring gaskets.**

**The use of quality market-proven corrosion-inhibiting coolants is always strongly recommended for any liquid cooling system.**

**Do not use pure distilled water as a cooling liquid! For best results, EK recommends the use of EK-CryoFuel Coolants.**

**Make sure to bleed air out of your water block thoroughly in order to reach optimal performance.**

# TABLE OF CONTENTS

<b>BOX CONTENTS</b>	<b>4</b>
<b>REQUIRED TOOLS</b>	<b>5</b>
<b>WATER BLOCK DIMENSIONS</b>	<b>5</b>
<b>TECHNICAL SPECIFICATIONS AND WATER BLOCK PARTS</b>	<b>6</b>
<b>PREPARING THE GRAPHICS CARD</b>	<b>7</b>
REMOVING THE STOCK BACKPLATE	7
REMOVING THE STOCK COOLER	7
CLEANING THE PCB	8
<b>CUTTING AND PLACING THERMAL PADS</b>	<b>9</b>
<b>APPLYING THERMAL COMPOUND</b>	<b>10</b>
<b>INSTALLING THE WATER BLOCK</b>	<b>10</b>
PLACING THE BLOCK ON THE GRAPHICS CARD	10
<b>CHECKING THE CONTACT IN CASE OF HIGH TEMPERATURES</b>	<b>11</b>
ATTACHING THE WATER BLOCK	11
<b>INSERTING THE GRAPHICS CARD INTO THE CHASSIS</b>	<b>12</b>
<b>INSTALLATION OF FITTINGS AND TUBING</b>	<b>12</b>
<b>CONNECTING THE D-RGB LED STRIP</b>	<b>13</b>
<b>TESTING THE LOOP</b>	<b>13</b>
<b>SUPPORT AND SERVICE</b>	<b>14</b>
<b>SOCIAL MEDIA</b>	<b>14</b>

# BOX CONTENTS

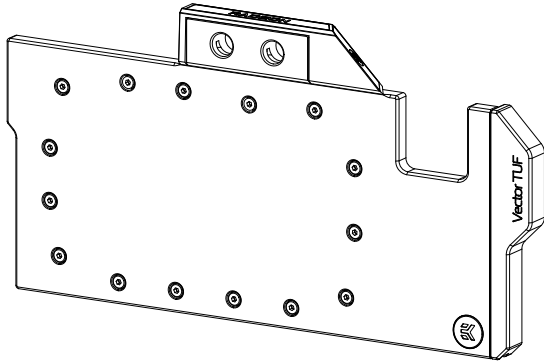

EK-Quantum Vector TUF RX 6800/6900 D-RGB

**Universal Mounting Mechanism** – You may not need every screw from this package.

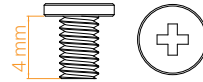

M2.5 x 4 AX1 Screw (30 pcs)

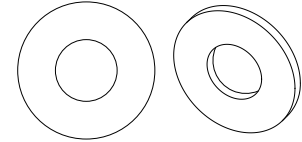

PVC Washer M2.5 (28 pcs)

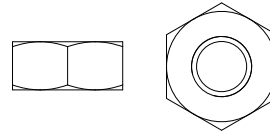

M2.5 Nut (1 pc)

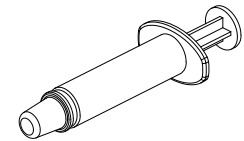

Thermal Grease (1 pc)



Allen Key 2 mm (1 pc)

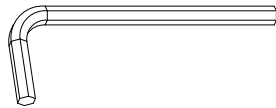

Allen Key 2.5 mm (1 pc)

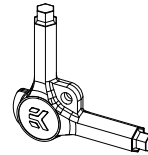

EK-Loop Multi Allen Key (1 pc)

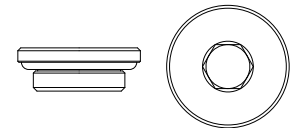

EK-Plug G1/4 (2 pcs)

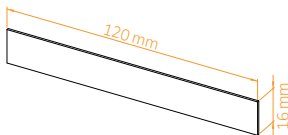

Thermal Pad F 1.0 mm (4 pcs)

## REQUIRED TOOLS

Phillips Head Screwdriver

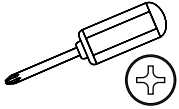

Scissors



## WATER BLOCK DIMENSIONS

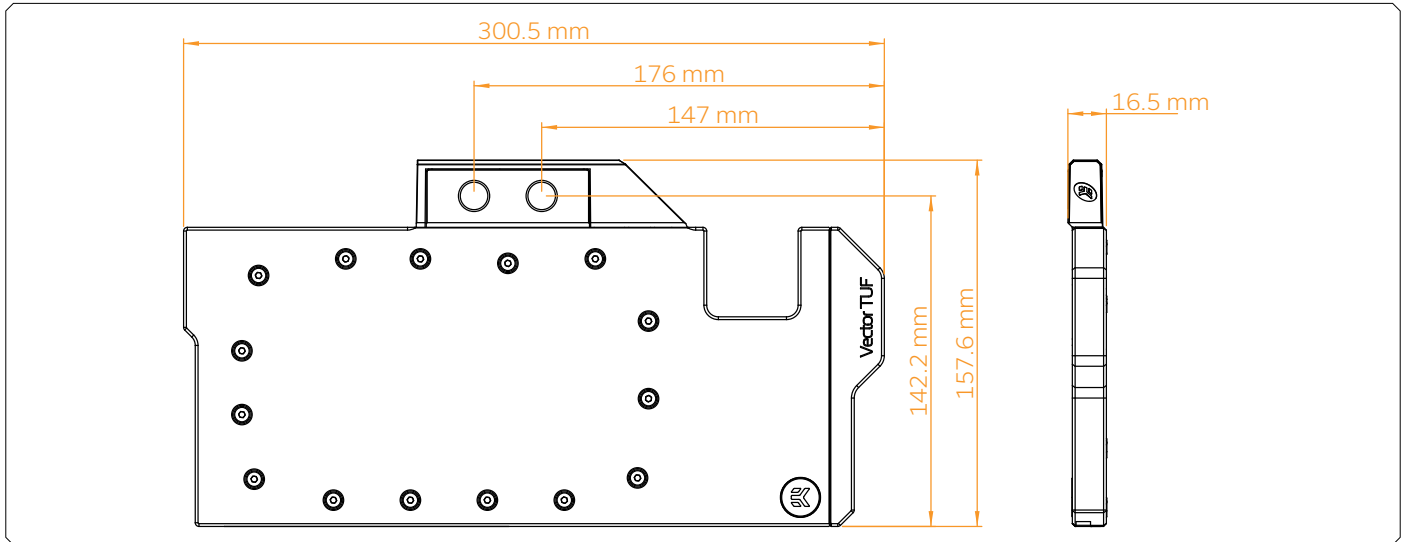

## TECHNICAL SPECIFICATIONS AND WATER BLOCK PARTS

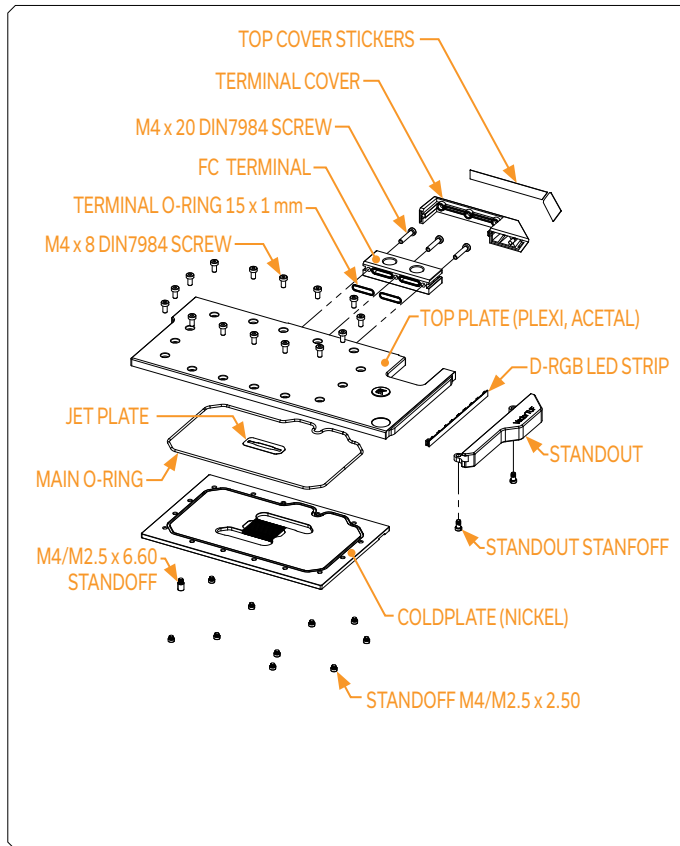

### Technical Specification:

- Dimensions (L x H x W): 300.5 x 157.5 x 16.5 mm
- D-RGB (Addressable RGB) Cable - Length: 500 mm
- D-RGB LED Count: Plexi - 9 / Acetal - 9
- D-RGB Connector: Standard 3-Pin (+5V, Data, Blocked, Ground)

## PREPARING THE GRAPHICS CARD

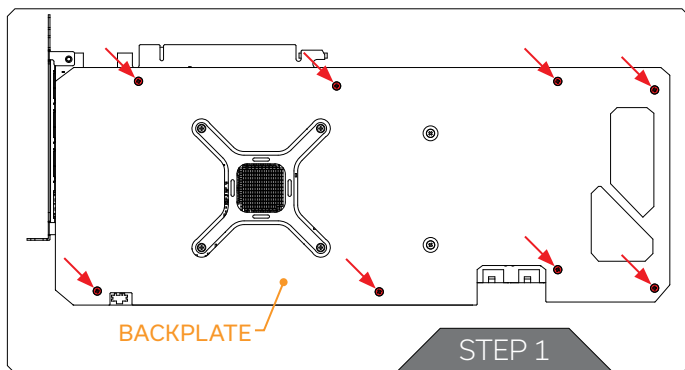

### REMOVING THE STOCK BACKPLATE

You will need the following tool:

Phillips Head Screwdriver

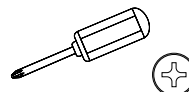

#### STEP 1

Place your graphics card on the flat surface and unscrew the eight (8) red marked screws from the GPU Backplate using Phillips head screwdriver. Carefully remove the Backplate from the GPU.

### REMOVING THE STOCK COOLER

#### STEP 1

After removing the backplate, unscrew the four (4) orange marked retention bracket screws and two (2) blue marked stock cooler screws. Also, two (2) green marked screws from the side of the I/O Bracket needs to be removed. Carefully remove the retention bracket and detach the PCB from the stock cooler. Disconnect all cables connecting the stock cooler to the PCB.



Always remove the stock cooler slowly - it might be firmly glued to the PCB with thermal pads.

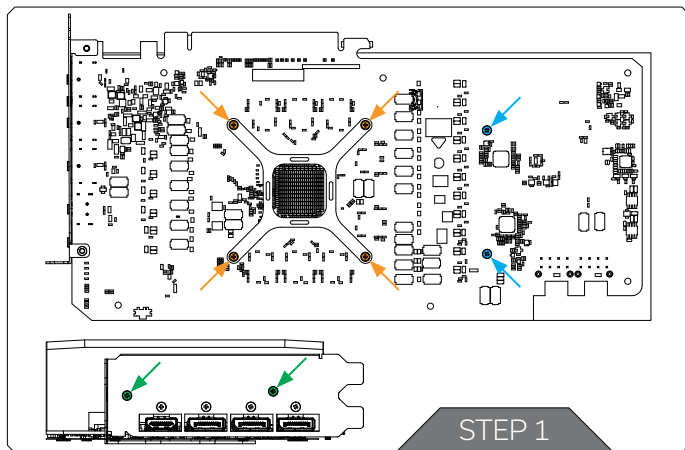

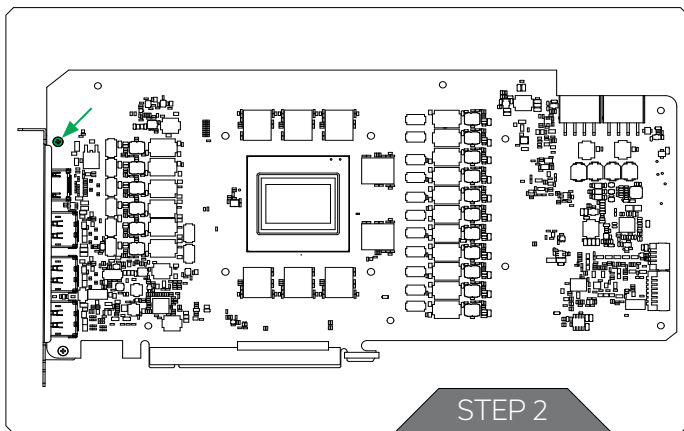

## STEP 2

Lastly, remove the green marked screw from the front side of the PCB. **The PCB is now ready for the water block installation.**

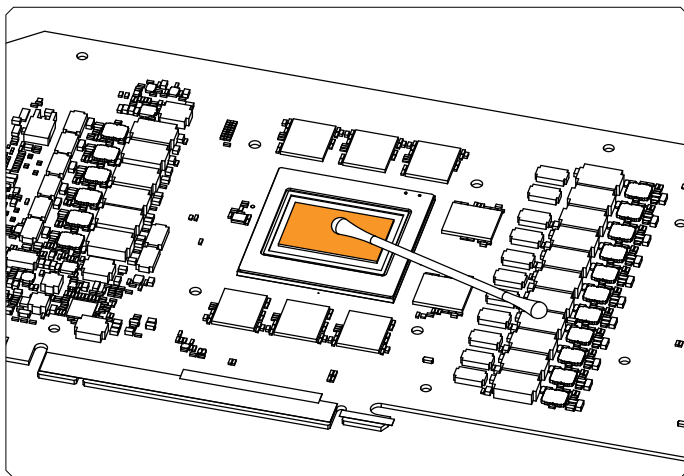

## CLEANING THE PCB

Wipe off the remains of the original thermal compound using a nonabrasive cloth or Q-tip, as shown in the sample image, until the components and circuit board are completely clean. EK recommends the use of denatured alcohol for removing TIM leftovers. After that, remove all remaining stock thermal pads from the PCB.



## CUTTING AND PLACING THERMAL PADS

**Thermal Pad F - 1.0 mm (120 x 16 mm)**



STEP 1

### STEP 1

Your GPU water block comes with thermal pads that have to be cut into smaller pieces to cover all the VRM components, such as COILs, MOSFETs, and drivers.



You must remove the protective foil from both sides of the thermal pad before installation.

Thermal pads:

4x Thermal Pad F 1.0 mm - (120 x 16 mm) EAN: 3830046996732

Thermal Pad F 1.0mm

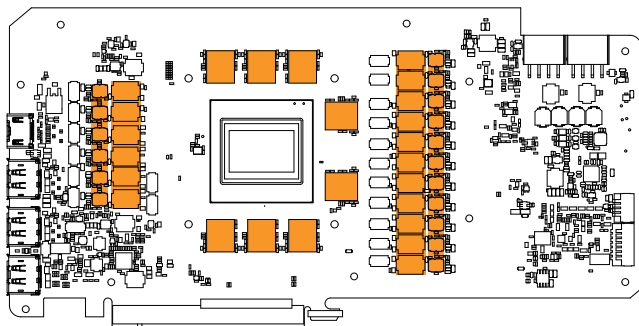

STEP 2

### STEP 2

Once cut to size, thermal pads should be placed on the PCB, as illustrated below. EK made sure to provide you with more than an adequate quantity of thermal pads to complete this Step.

## APPLYING THERMAL COMPOUND

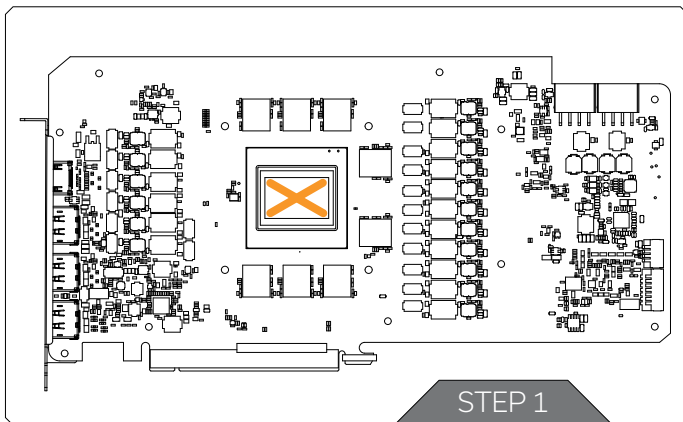

### STEP 1

Apply the enclosed EK-TIM Ectotherm thermal grease (thermal compound) on the GPU heat spreader - IHS - as shown in the image. The layer of the thermal compound must be thin and even over the entire surface of the IHS.



The excessive or uneven application of thermal grease may lead to poor performance!

For this Step, you will need:

Thermal Grease

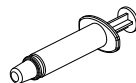

## INSTALLING THE WATER BLOCK

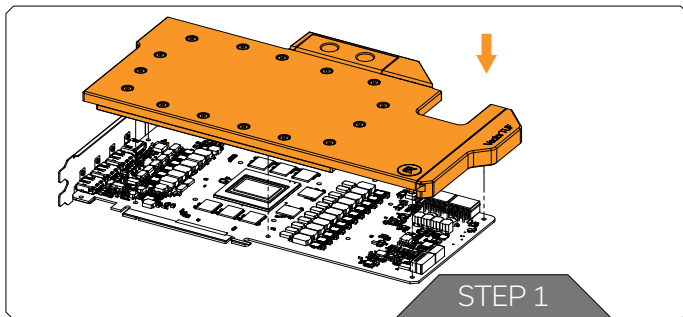

### STEP 1

#### PLACING THE BLOCK ON THE GRAPHICS CARD

This procedure is the same for all full-cover water blocks.

Carefully position the water block with preinstalled standoffs on the graphics card. During this process, make sure you have aligned mounting holes of the PCB with holes of the water block (same applies to other tops).



Pay attention not to use too much force when pressing the block down to the PCB since chip dies are prone to cracking.

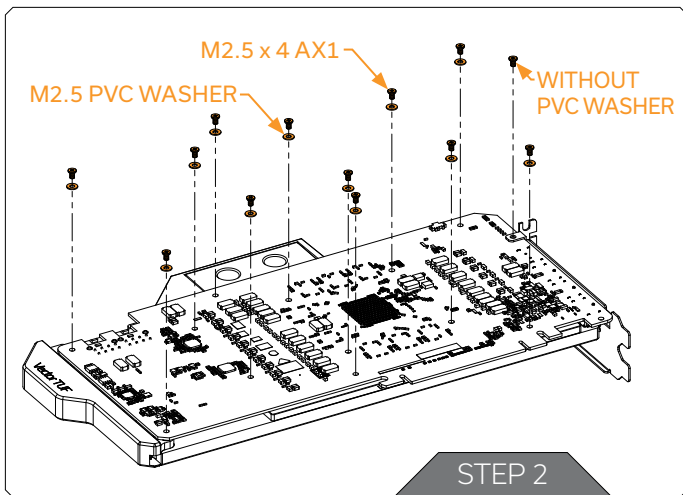

## STEP 2

### ATTACHING THE WATER BLOCK

Use thirteen (13) M2.5 x 4 AX1 screws and twelve (12) M2.5 PVC washers. Tighten the screws evenly using the Phillips head screwdriver. EK recommends you start tightening the screws around the GPU core first and then continuing outward to prevent damage to the GPU.

For this Step, you will need:

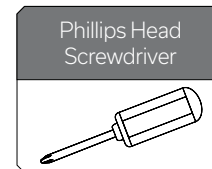
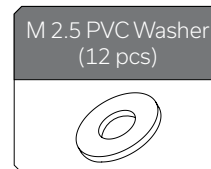
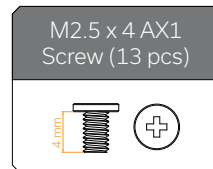

## CHECKING THE CONTACT IN CASE OF HIGH TEMPERATURES

If necessary, temporarily remove the water block to check for uniform surface contact between the block and components. Pay special attention to the VRM section of the graphics card. Check whether the water block makes contact with the intended integrated circuit. Then repeat Steps from the previous section to re-attach the block.



In case you fail to obtain good contact, please check again or contact our support service at <https://www.ekwb.com/customer-support/>.

## INSERTING THE GRAPHICS CARD INTO THE CHASSIS

Carefully lift your graphics card with the installed water block and insert it into your PC's motherboard PCIe express expansion slot. Please keep in mind that your graphics card is heavier than before it was equipped with the water block.



You need to be very careful when handling the graphics card. Avoid all unnecessary manipulation of the water block assembly that might damage your card or water block.

## INSTALLATION OF FITTINGS AND TUBING

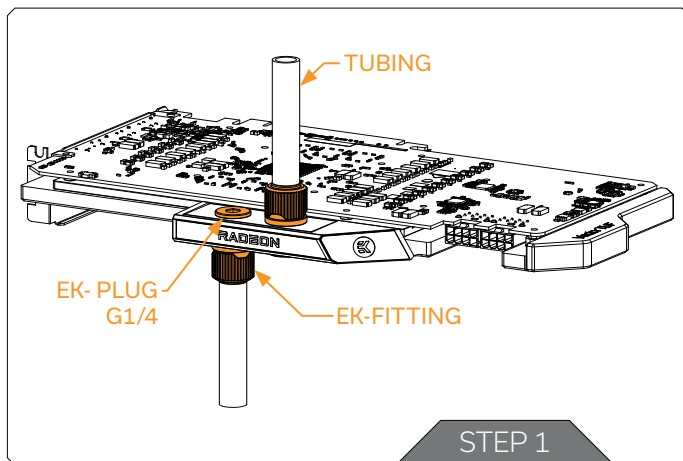

### STEP 1

Screw in two (2) G1/4 threaded male fittings. Attach the liquid cooling tubes and connect the water block(s) to the cooling loop.



Do not forget to plug the remaining two openings with enclosed EK-Plug G1/4 or its equivalent.

**EK recommends using EK fittings with all EK water blocks.**



**CAUTION:** When using connectors other than EK fittings, pay special attention to the length of the fittings male G1/4" thread - 5 mm is the maximum G1/4" thread length allowed!

## CONNECTING THE D-RGB LED STRIP

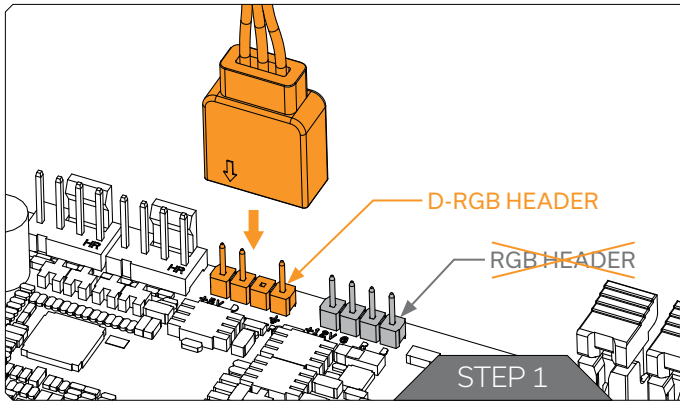

### STEP 1

Plug the **4-pin D-RGB** connector from the GPU water block to the **D-RGB Header** on your motherboard or controller. The LED strip will work only if the pin layout on the header is as follows: **+5V, Data, Empty, Ground**.



Incorrect installation or installation to a wrong header can damage the LED strip or the header itself!

## TESTING THE LOOP

To ensure the installation of EK components was successful, we recommend you perform a 24-hour leak test.

When your loop is complete and filled with coolant, connect the pump to a PSU outside your system. Do not connect power to any of the other components. Turn on the PSU and let the pump run continuously.

Inspect all parts of the loop, and in case the coolant leaks, fix the issue and repeat the testing process. To prevent possible damage, please ensure all hardware is dry before the system is powered on.

## SUPPORT AND SERVICE

In case you need assistance, please contact:

<http://support.ekwb.com/>

EKWB d.o.o.  
Pod lipami 18  
1218 Komenda  
Slovenia - EU

## SOCIAL MEDIA

 EKWaterBlocks

 @EKWaterBlocks

 ekwaterblocks

 EKWBofficial

 ekwaterblocks

