

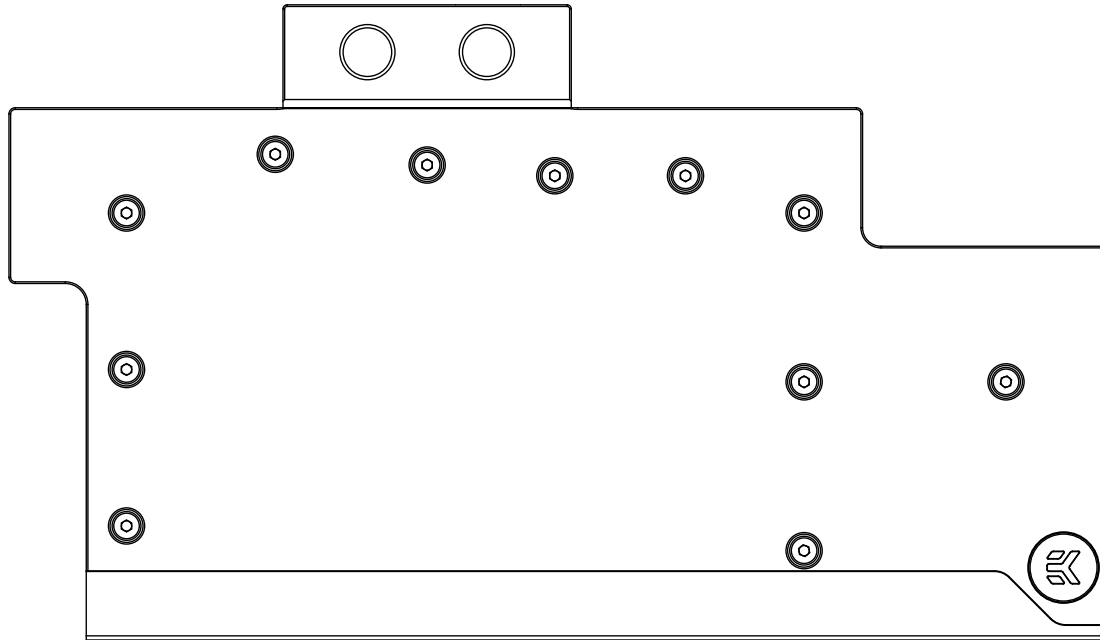

EK-Classic GPU Water Block Strix RTX 3080/3090 D-RGB

GPU WATER BLOCK



Before you start using this product, please follow these basic guidelines:

Carefully read the manual before beginning with the installation process.

Remove your graphics card from the computer for the safest mounting process to prevent any possible damage to your GPU or its circuit board (PCB).

EK Fittings require only a small amount of force to screw them firmly in place since the liquid seal is ensured with the rubber O-ring gaskets.

The use of quality market-proven corrosion-inhibiting coolants is always strongly recommended for any liquid cooling system.

Do not use pure distilled water as a cooling liquid! For best results, EK recommends the use of EK-CryoFuel Coolants.

Make sure to bleed air out of your water block thoroughly in order to reach optimal performance.

TABLE OF CONTENTS

BOX CONTENTS	4
REQUIRED TOOLS	5
WATER BLOCK DIMENSIONS	5
WATER BLOCK SPECIFICATIONS AND MAIN PARTS	6
PREPARING THE GRAPHICS CARD	7
REMOVING THE STOCK COOLER	7
REMOVING THE STOCK BACKPLATE	8
CLEANING THE PCB	9
CUTTING AND PLACING THERMAL PADS	9
APPLYING THERMAL COMPOUND	10
INSTALLING THE WATER BLOCK	11
PLACING THE BLOCK ON THE GRAPHICS CARD	11
ATTACHING THE BLOCK TO THE GRAPHICS CARD	11
CHECKING FOR CONTACT	12
INSERTING THE GRAPHICS CARD INTO THE CHASSIS	12
INSTALLATION OF FITTINGS AND TUBING	13
CONNECTING THE D-RGB LED STRIP	13
TESTING THE LOOP	14
SUPPORT AND SERVICE	15
SOCIAL MEDIA	15

BOX CONTENTS

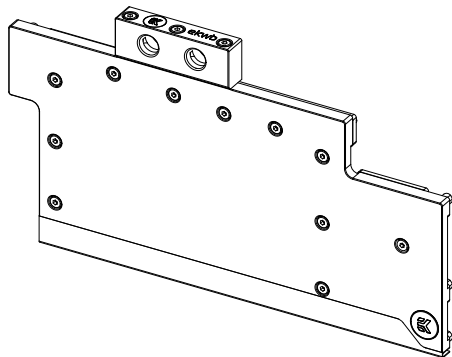

EK-Classic GPU Water Block Strix RTX 3080/3090 D-RGB

Mounting mechanism - You may not need all the screws, mounting mechanism is universal!

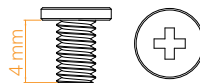

M2,5x4 AX1 Screw (16 pcs)

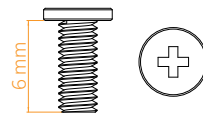

M2,5x6 AX1 Screw (13 pcs)

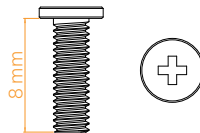

M2,5x8 AX1 Screw (2 pcs)

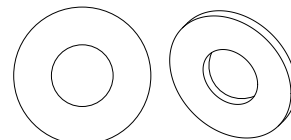

M2.5 PVC Washers (16 pcs)

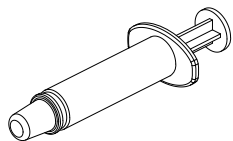

Thermal Grease (1 pc)

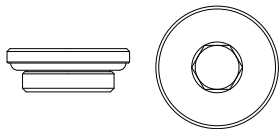

EK-Plug G1/4 (2 pcs)

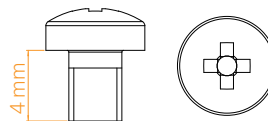

M3x4 DIN7985 Screw (2 pcs)

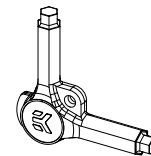

EK-Loop Multi Allen Key (1 pc)

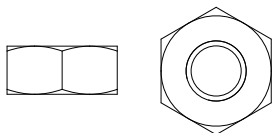

M2.5 Nut (2 pcs)



Allen Key 2.5. mm (1 pc)

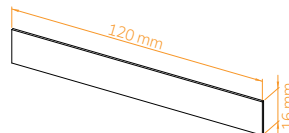

Thermal Pad F 1.0 mm (5 pcs)

REQUIRED TOOLS

Phillips Head Screwdriver

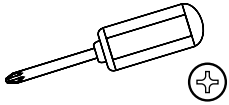

Torx T6 Screwdriver

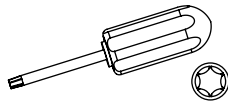

Scissors

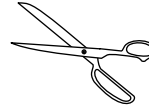

WATER BLOCK DIMENSIONS

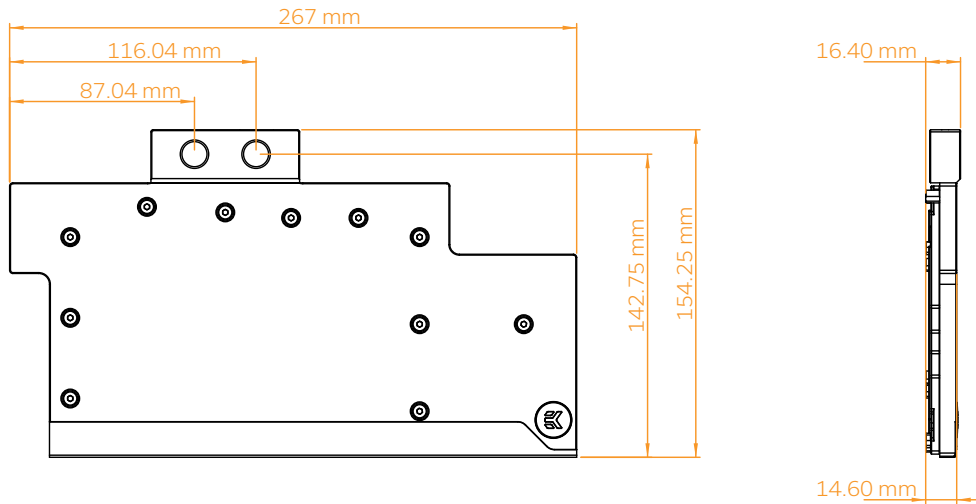

WATER BLOCK SPECIFICATIONS AND MAIN PARTS

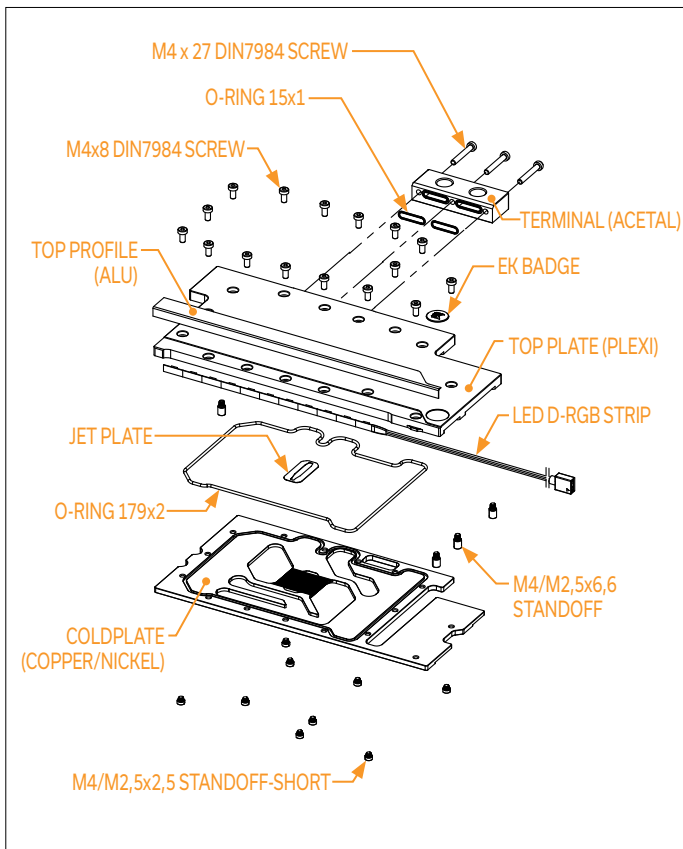

Technical Specification:

- Dimensions: (LxHxW) – 267 x 154 x 16.4 mm
- D-RGB (Addressable RGB) cable length: 500 mm
- D-RGB LED COUNT: 11
- D-RGB connector standard 3-pin (+5V, Data, Blocked, Ground)

PREPARING THE GRAPHICS CARD

For this Step, you will need:

Phillips Head Screwdriver

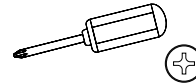

Torx T6 Screwdriver

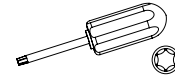

STEP 1 REMOVING THE STOCK COOLER

Use the Phillips head screwdriver to remove the three screws from the GPU bracket side and six screws from the side of the backplate.

After removing all nine screws (marked in the picture), carefully detach the PCB with the backplate from the stock cooler and disconnect two cables connected to the PCB.



Always remove the stock cooler slowly - it might be firmly glued to the PCB with thermal pads.

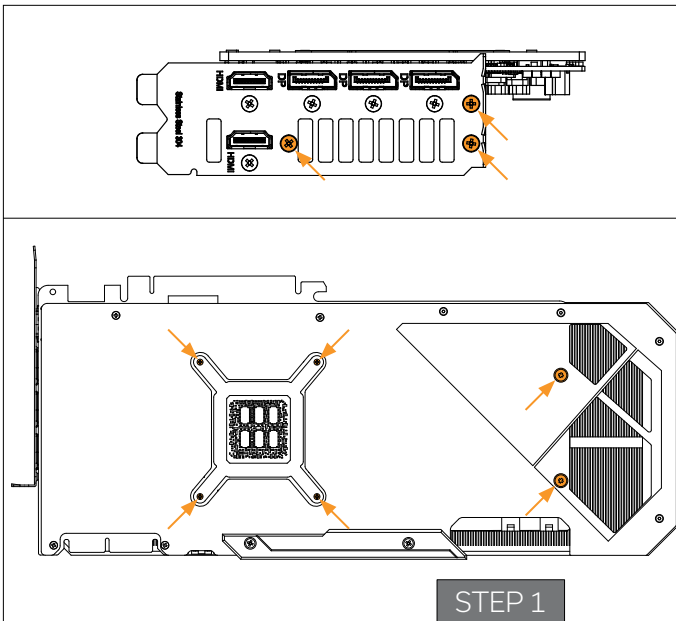

STEP 2 REMOVING THE STOCK BACKPLATE

Use the Phillips head screwdriver to remove the two screws attaching the GeForce® RTX™ plate to the backplate.

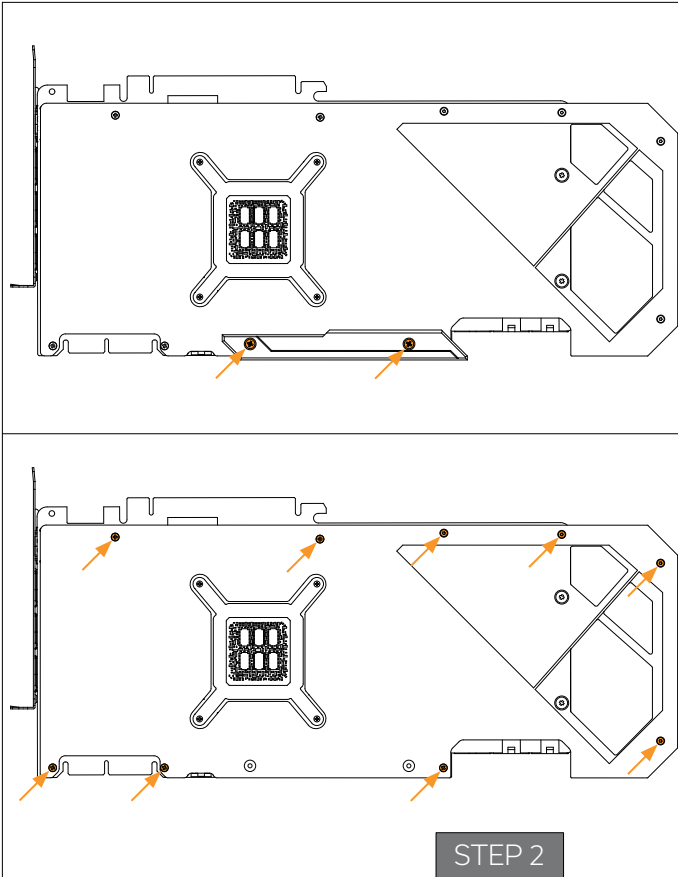

Remove the nine screws with Phillips and Torx head screwdrivers and carefully detach the stock backplate from the PCB.

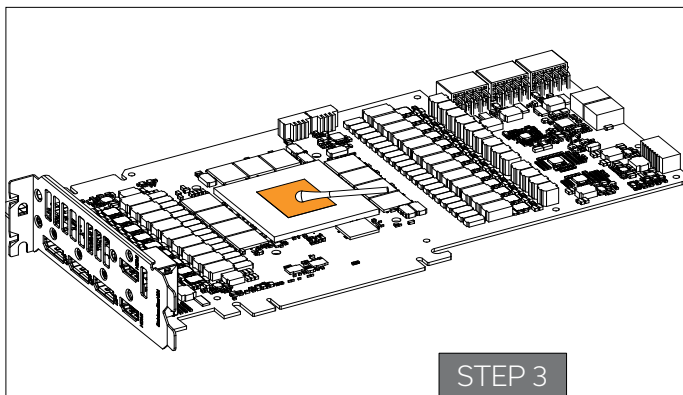

STEP 3 CLEANING THE PCB

Wipe off the remains of the original thermal compound using a nonabrasive cloth or Q-tip, as shown in the sample image, until the components and circuit board are completely clean. EK recommends the use of denatured alcohol for removing TIM leftovers. After that, remove all remaining stock thermal pads from the PCB.

CUTTING AND PLACING THERMAL PADS

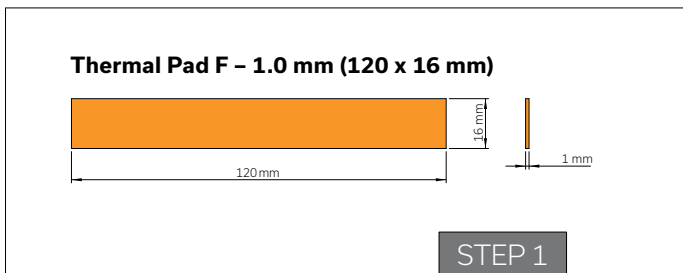

STEP 1

Your GPU water block comes with thermal pads that have to be cut into smaller pieces to cover all the VRM components, such as COILs, MOSFETs, and drivers.



You must remove the protective foil from both sides of the thermal pad before installation.

Thermal pads:
5x Thermal Pad F 1.0 mm - (120 x 16 mm) EAN: 3830046996732

Strix RTX™ 3080/3090

Thermal Pad F 1.0 mm

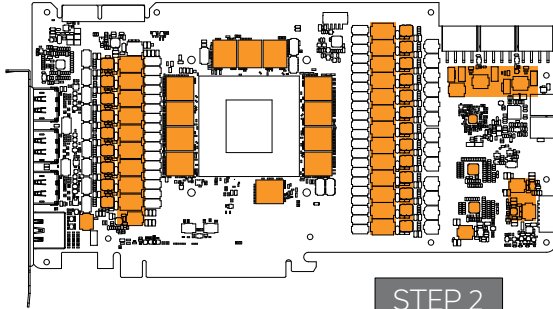

STEP 2

Once cut to size, thermal pads should be placed on the PCB, as illustrated below. EK made sure to provide you with more than an adequate quantity of thermal pads to complete this Step.

APPLYING THERMAL COMPOUND

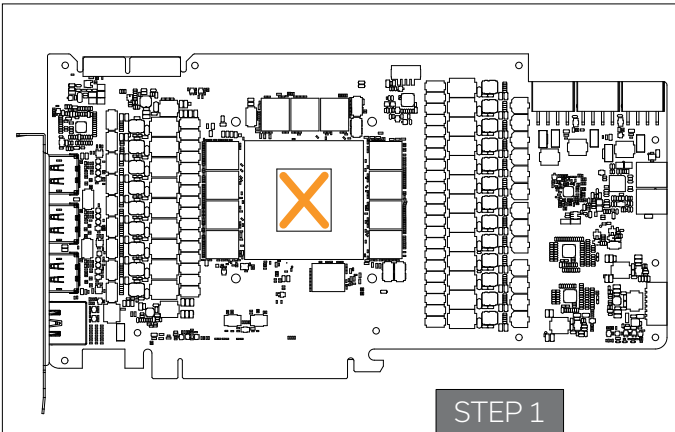

For this Step, you will need:

Thermal Grease

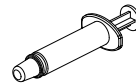

STEP 1

Apply the enclosed EK-TIM Ectotherm thermal grease (thermal compound) on the CPU heat spreader – IHS – as shown in the image. The layer of the thermal compound must be thin and even over the entire surface of the IHS.



The excessive or uneven application of thermal grease may lead to poor performance!

INSTALLING THE WATER BLOCK

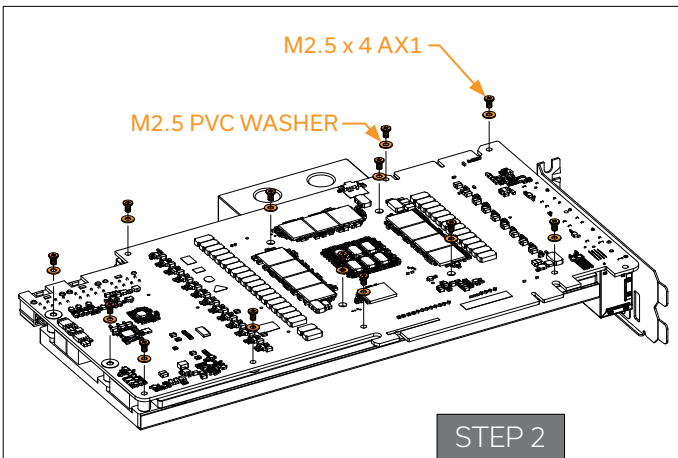
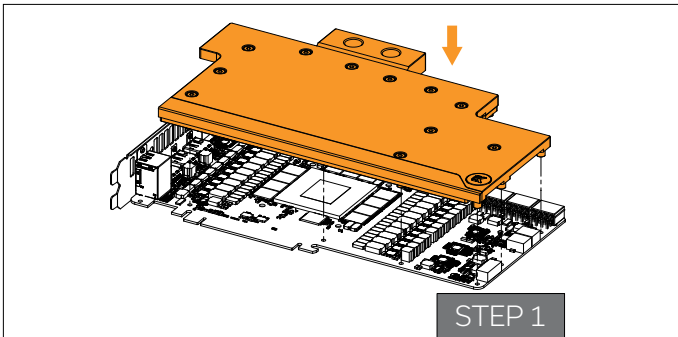

For this Step, you will need:

M2.5 x 4 AX1
13 pcs



M 2.5 PVC Washer
13 pcs



Phillips Head
Screwdriver

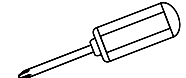

STEP 1

PLACING THE BLOCK ON THE GRAPHICS CARD

This procedure is the same for all full-cover water blocks.

Carefully position the water block with preinstalled standoffs on the graphics card. During this process, make sure you have aligned mounting holes of the PCB with holes of the water block (same applies to other tops).



Pay attention not to use too much force when pressing the block down to the PCB since chip dies are prone to cracking.

STEP 2

ATTACHING THE BLOCK TO THE GRAPHICS CARD

Use thirteen (13) M2.5 x 4 AX1 screws and M2.5 PVC washers. Tighten the screws evenly using the Phillips head screwdriver. EK recommends you start tightening the screws around the GPU core first and then continuing outward to prevent the damage to the GPU. Always use a plastic washer under each screw!

CHECKING FOR CONTACT

If necessary, temporarily remove the water block to check for uniform surface contact between the block and components. Pay special attention to the VRM section of the graphics card. Check whether the water block makes contact with the intended integrated circuit. Then repeat Steps from the previous section to re-attach the block.



In case you fail to obtain good contact, please check again or contact our support service at <https://www.ekwb.com/customer-support/>.

INSERTING THE GRAPHICS CARD INTO THE CHASSIS

Carefully lift your graphics card with the installed water block and insert it into your PC's motherboard PCIe expansion slot. Please keep in mind that your graphics card is heavier than before it was equipped with the water block.



You need to be very careful when handling the graphics card. Avoid all unnecessary manipulation of the water block assembly that might damage your card or water block.

INSTALLATION OF FITTINGS AND TUBING

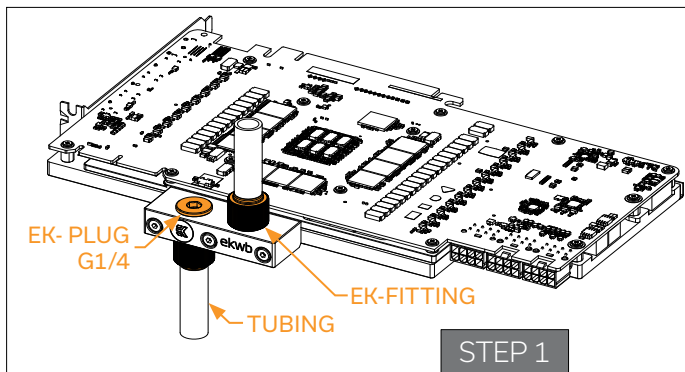

STEP 1

Screw-in two (2) G1/4 threaded male fittings. Attach the liquid cooling tubes and connect the water block(s) to the cooling loop.



Do not forget to plug the remaining two openings with enclosed EK-Plug G1/4 or its equivalent.

You can use any opening as an inlet/outlet port.

EK recommends using EK fittings with all EK water blocks.



CAUTION: When using connectors other than EK fittings, pay special attention to the length of the fittings' male G1/4" thread - 5mm is the maximum G1/4" thread length allowed!

CONNECTING THE D-RGB LED STRIP

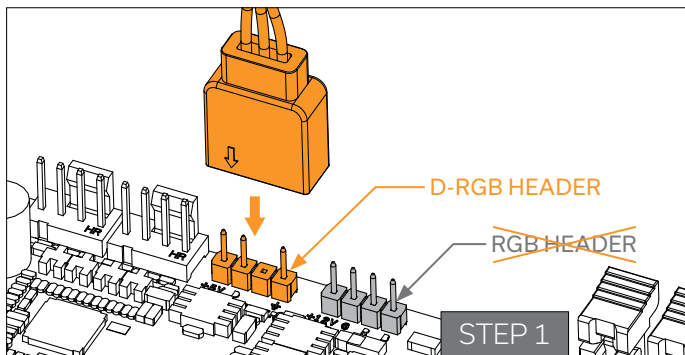

STEP 1

Plug the **4-pin D-RGB** connector from the GPU water block to the **D-RGB Header** on your motherboard or controller. The LED strip will work only if the pin layout on the header is as follows: **+5V, Data, Empty, Ground**.



Incorrect installation or installation to a wrong header can damage to the LED strip or the header itself!

TESTING THE LOOP

To make sure the installation of EK components was successful, we recommend you perform a 24-hour leak test.

When your loop is complete and filled with coolant, connect the pump to a PSU outside of your system. Do not connect power to any of the other components. Turn on the PSU and let the pump run continuously.

Inspect all parts of the loop, and in case the coolant leaks, fix the issue and repeat the testing process. To prevent possible damage, please ensure that all hardware is dry before the system is powered on.

SUPPORT AND SERVICE

In case you need assistance, please contact:

<http://support.ekwb.com/>

EKWB d.o.o.
Pod lipami 18
1218 Komenda
Slovenia - EU

SOCIAL MEDIA

 EKWaterBlocks

 @EKWaterBlocks

 ekwaterblocks

 EKWBofficial

 ekwaterblocks

