

# EK-Vardar Fan Set



This product is intended for installation only by expert users. Please consult with a qualified technician for installation. Improper installation may result in damage to your equipment. EK Water Blocks assumes no liability whatsoever, expressed or implied, for the use of these products, nor their installation. The following instructions are subject to change without notice. Please visit our web site at [www.ekwb.com](http://www.ekwb.com) for updates.

Before you start using this product please follow these basic guidelines:

**Please carefully read the manual through before beginning with the installation process!**

**Please use only the enclosed screws. Using inappropriate screws may result in radiator puncture leading to leakage of the cooling fluid.**

# TABLE OF CONTENT

<b>CONTENTS OF THE PACKAGE</b>	<b>4</b>
<b>INSTALLING THE FAN DIRECTLY</b>	<b>5</b>
<b>INSTALLING THE FAN ON TO THE RADIATOR</b>	<b>6</b>
<b>CONNECTING THE FANS</b>	<b>6</b>
<b>SUPPORT AND SERVICE</b>	<b>8</b>
<b>SOCIAL MEDIA</b>	<b>8</b>

## CONTENTS OF THE PACKAGE

### 240/280 VERSION:

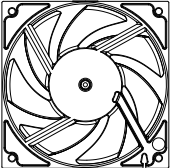
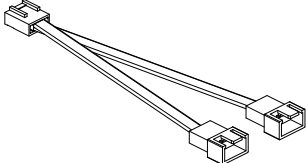
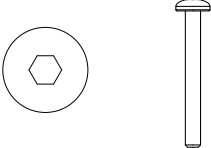
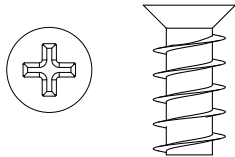
EK -Vardar 120/140 FANS	2-way fan splitter	Radiator mounting screws (UNC #6-32)	Self tapping mounting screws
			

### 360 VERSION:

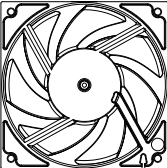
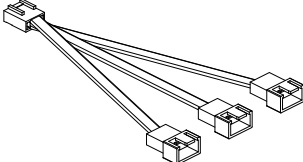
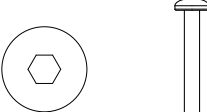
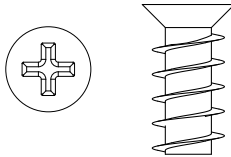
EK -Vardar 120/140 FANS	3-way fan splitter	Radiator mounting screws (UNC #6-32)	Self tapping mounting screws
			

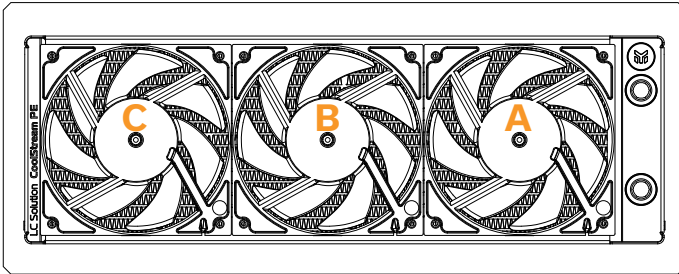

Each of the fans has a different cable length, because every fan is intended for a specific position on the radiator. The fan with the longest cable should be positioned furthest away from the splitter so that the shorter fan cables will reach the splitter perfectly.

- Cable lengths for different radiator versions:
- A. 170mm
  - B. 300mm
  - C. 420mm

## INSTALLING THE FAN DIRECTLY

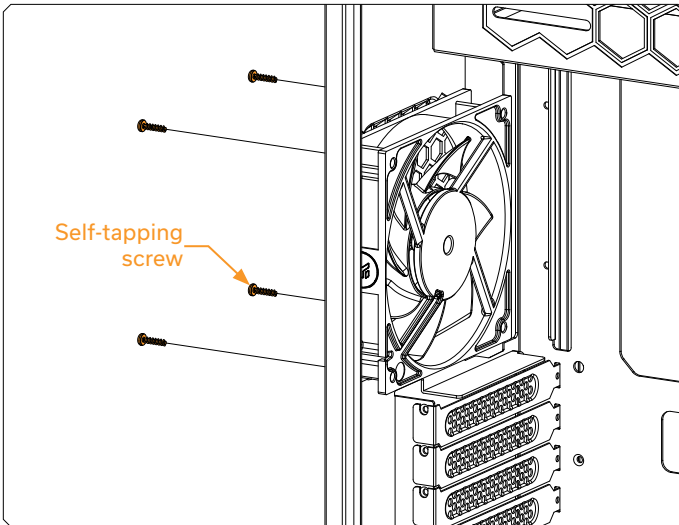

EK-Vardar fans can be mount directly into the chassis using enclosed self-tapping fan screws (see sample photo).

## INSTALLING THE FAN ON TO THE RADIATOR

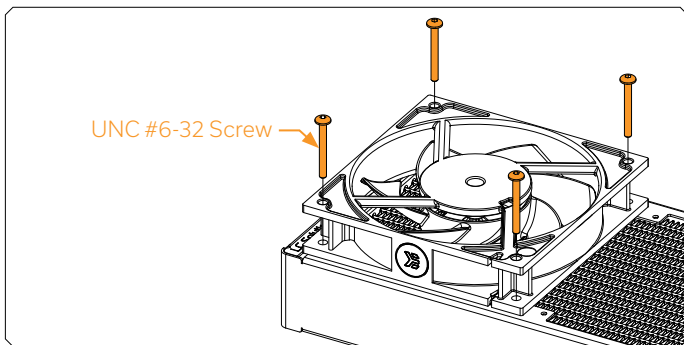

EK-Vardar fans can be mounted onto the radiator using UNC #6-32 mounting screws (as shown on the photo). Tighten the screws evenly and do not use excessive force!

## CONNECTING THE FANS

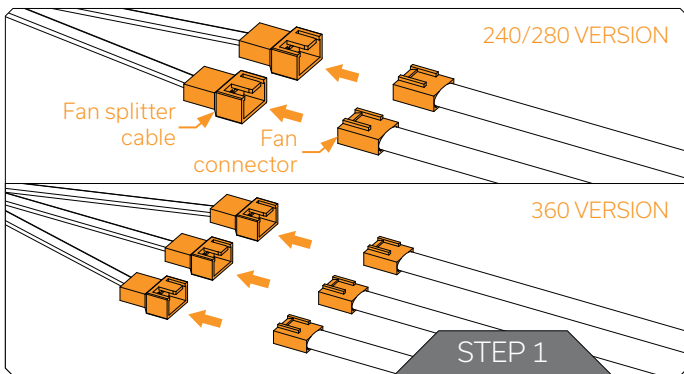

In order to connect the fans you may use the enclosed fan splitter adapters to reduce the number of headers required.

### STEP 1

Connect the female connectors of the fans to the male connectors on the fan splitter cable.

## STEP 2

Connect the female splitter connector to a header located on the motherboard or fan controller. Where possible use a header designated for the CPU.

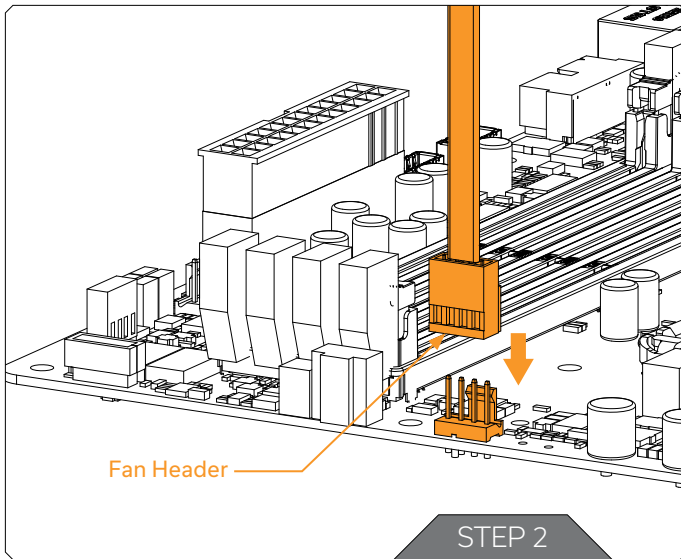

## SUPPORT AND SERVICE

For assistance please contact:

<http://support.ekwb.com/>

EKWB d.o.o.  
Pod lipami 18  
1218 Komenda  
Slovenia - EU

## SOCIAL MEDIA

 EKWaterBlocks

 @EKWaterBlocks

 ekwaterblocks

 EKWBofficial

 ekwaterblocks

 discord.gg/zesFRJB

