

EK-Quantum Vector Strix RX 5700 +XT Backplate

BACKPLATE

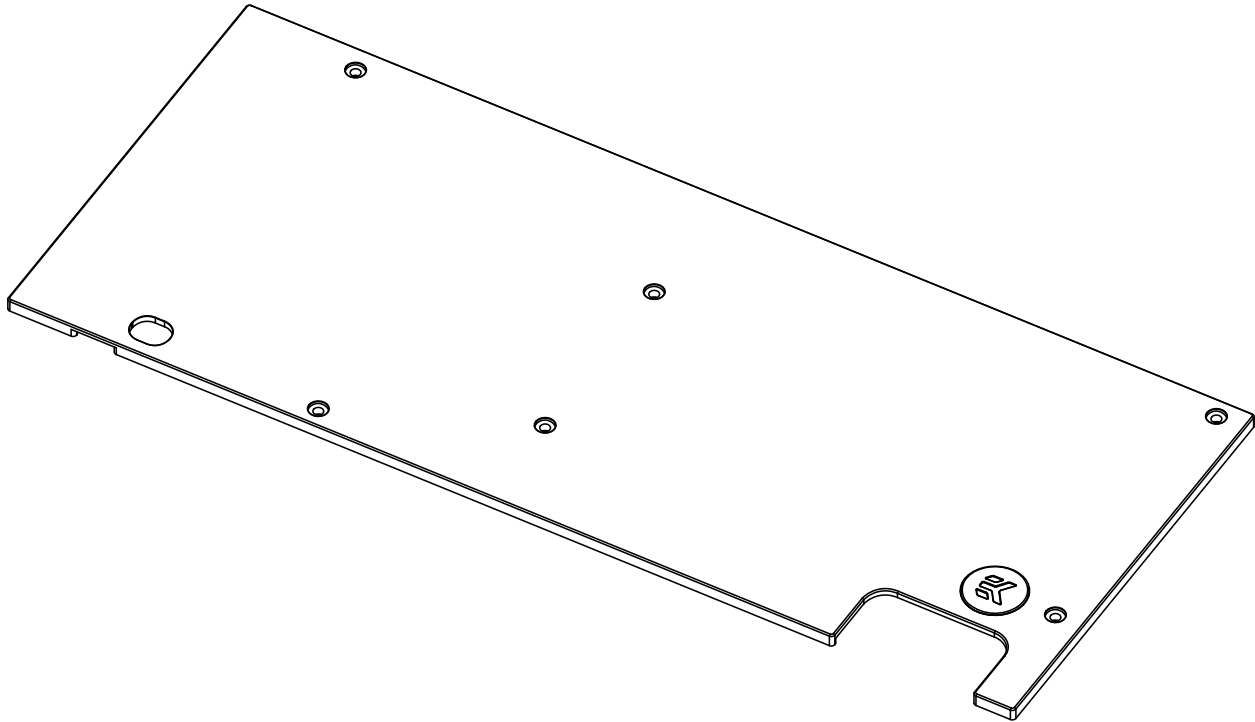

This product is intended for installation only by expert users. Please consult with a qualified technician for installation. Improper installation may result in damage to your equipment. EK Water Blocks assumes no liability whatsoever, expressed or implied, for the use of these products, nor their installation. The following instructions are subject to change without notice. Please visit our web site at www.ekwb.com for updates. Before installation of this product please read important notice, disclosure and warranty conditions printed on the back of the box.

Before you start using this product please follow these basic guidelines:

Please carefully read the manual thoroughly before beginning with the installation process!

Please remove your graphics card from the computer to assure safest mounting process in order to prevent any possible damages to your GPU and/or graphics card circuit board (PCB).

This product is anticipated to be used exclusively with EK-Quantum Vector Strix RX 5700 blocks and has not been tested with any factory or aftermarket heatsinks and water blocks. EK does not provide any assistance or support in the latter application.

TABLE OF CONTENT

INSTALLING THE BACKPLATE	4
IMPORTANT DISCLOSURES	6
REQUIRED TOOLS	6
SUPPORT AND SERVICE	7
SOCIAL MEDIA	7

INSTALLING THE BACKPLATE

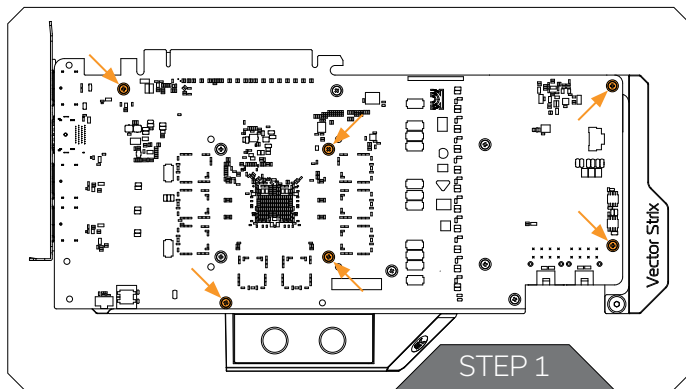

STEP 1 PREPARING YOUR GRAPHICS CARD

First complete the installation of your EK-Quantum Vector Strix RX 5700 Water Block according to its installation manual. Using the Phillips head screwdriver remove the six(6) screws and their PVC washers which are marked below.

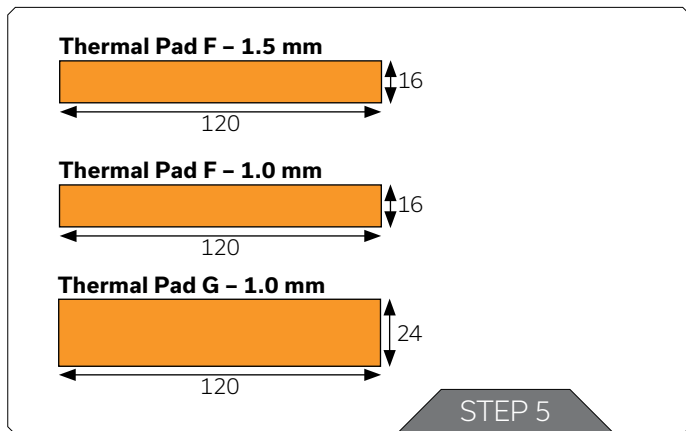

STEP 2 CUTTING THERMAL PADS

Your backplate is supplied with thermal pads that needs to be cut into smaller pieces in order to cover all VRM components.

PLEASE REMOVE THE PROTECTIVE FOIL FROM BOTH SIDES OF THE THERMAL PADS PRIOR TO INSTALLATION.

Replacement thermal pads:

Thermal PAD F 1,5 mm - (120 x 16 mm) - 3830046996749

Thermal PAD F 1,0 mm - (120 x 16 mm) - 3830046996732

Thermal PAD G 1,0 mm - (120 x 24 mm) - 3830046996770

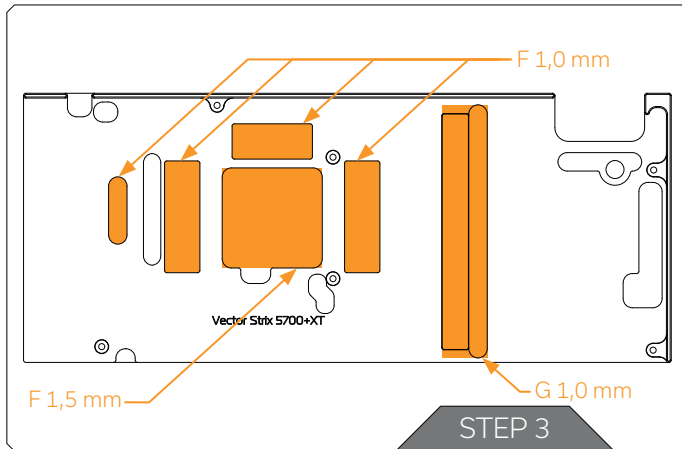

STEP 3 PLACING THERMAL PADS

Once cut to size thermal pads should be applied to the backplate as illustrated.

EK made sure to provide customers with more than adequate quantity of thermal pads to complete this step.

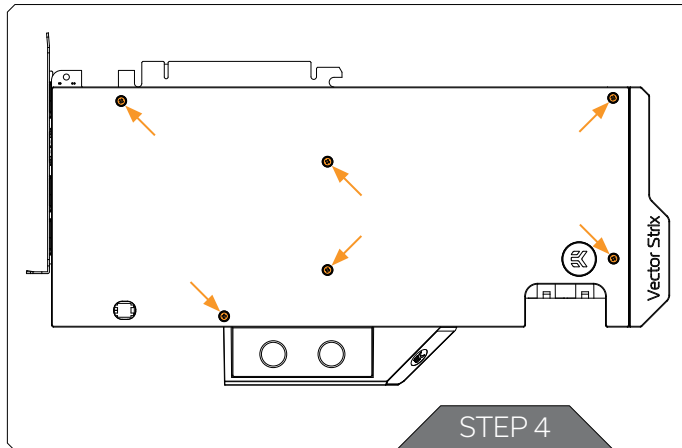

STEP 4 ATTACHING THE BACKPLATE

Place the backplate on to the PCB aligning all of the holes. Position an M2.5X7 AX1 screw in each of the (6) mounting holes marked below and then tighten them evenly using a Phillips head screwdriver. Do not use excessive screwing force.

IMPORTANT DISCLOSURES

IMPORTANT NOTICE

Once the installation is completed, it is a recommended practice to test the cooling circuit for leaks prior to powering up the computer. We recommend a 24 hour leak test prior to powering up the computer. Do not test the water block using city water pressure. This will rupture the top of the housing and render the block unusable (and will void your warranty). While all efforts have been made to provide the most comprehensive tutorial possible, EK Water Blocks assumes no liability expressed or implied for any consequential damage(s) occurring to your equipment as a result of using EK Water Blocks cooling products, either due to errors or omissions on our part in the above instructions, or due to failure or defect in the EK Water Blocks cooling products.

WARRANTY

Our products are warranted against defects in materials or workmanship for a period of 24 months beginning from the date of delivery to the final user. During this period, products will be repaired or have parts replaced at our discretion provided that: (I) the product

is returned to the agent from whom it was purchased; (II) the product has been purchased by an end user and has not used for commercial purposes; (III) the product has not been misused, handled carelessly, or used in a manner other than in accordance with the instructions provided describing its installation and proper use. This warranty does not confer rights other than those expressly set out above and does not cover any claims for consequential loss or damage. This warranty is offered as an extra benefit and does not affect your statutory rights as a consumer. This warranty is voided if the product comes in contact with aggressive UV additives or other improper liquids. EK blocks are sealed with warranty void circular label, which proves that the block has withstood a pressure leak test. Removing it will void leak-free guarantee and not the guarantee on the product itself. Any other RMA issues can be reported to EK Support at www.ekwb.com/support for further analysis.

REQUIRED TOOLS

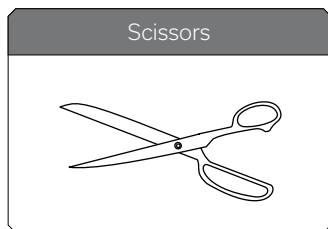
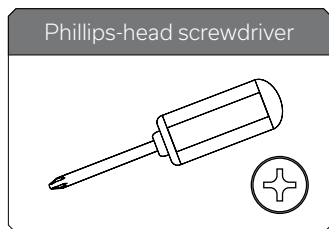

SUPPORT AND SERVICE

For assistance please contact:

<http://support.ekwb.com/>

EKWB d.o.o.
Pod lipami 18
1218 Komenda
Slovenia - EU

SOCIAL MEDIA

 EKWaterBlocks

 @EKWaterBlocks

 ekwaterblocks

 EKWBofficial

 ekwaterblocks

