

This product is intended for installation only by expert users. Please consult with a qualified technician for installation. Improper installation may result in damage to your equipment. EK Water Blocks assumes no liability whatsoever, expressed or implied, for the use of these products, nor their installation. The following instructions are subject to change without notice. Please visit our web site at [www.ekwb.com](http://www.ekwb.com) for updates. Before installation of this product please read important notice, disclosure and warranty conditions printed on the back of the box.

Before you start using this product please follow these basic guidelines:

1. Please carefully read the manual before through before beginning with the installation process!
2. Please remove your motherboard from the computer to assure safest mounting process in order to prevent any possible damages to your CPU and/or motherboard's circuit board (PCB).
3. The EK High Flow and EK-CSQ type fittings require only a small amount of force to screw them firmly in place since the liquid seal is ensured by the rubber o-ring gaskets.
4. The use of quality, market proved corrosion inhibiting coolants is always strongly recommended for any liquid cooling system.

## STEP 1: GENERAL INFORMATION Sample photo of ASUS Rampage V Extreme motherboard

### IMPORTANT NOTICE:

ROG LED (Logo) has to be removed in order to successfully complete installation of the FB KIT ASUS R5E and cannot be used in combination with the FB KIT ASUS R5E.

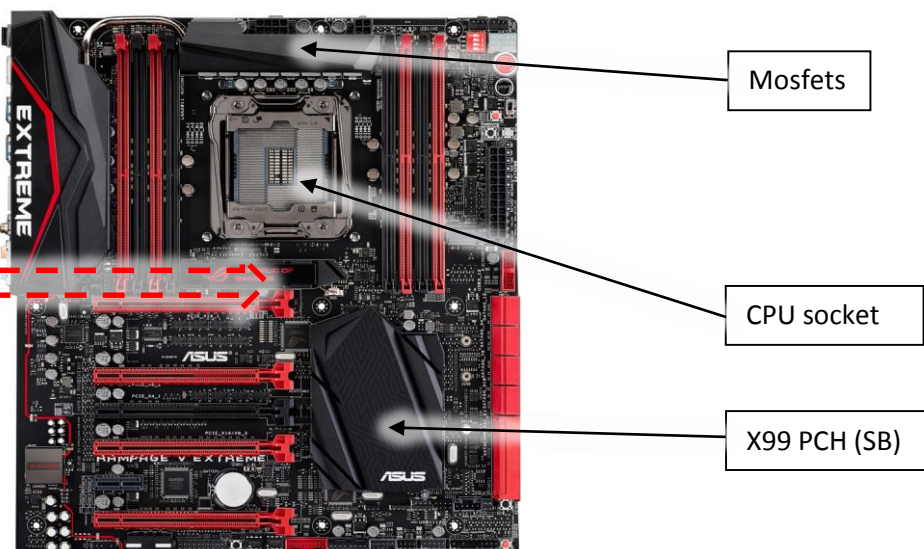

## STEP 1: PREPARING YOUR MOTHERBOARD

1. REMOVING STOCK COOLER. Remove all encircled screws. There are 13 screws on the back of the motherboard that needs to be removed in order to remove the factory installed SB/MOSFET heat pipe cooling solution.

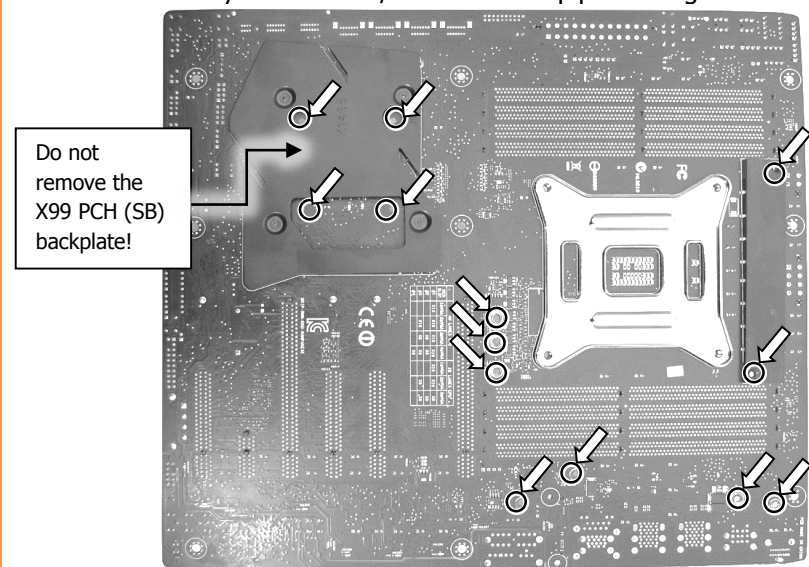

## STEP 2: REMOVING THE ORIGINAL LATCH MECHANISM BACKPLATE

Please remove your motherboard from the computer to assure safest mounting process possible in order to prevent any possible damages to your PCB. With the enclosed Torx T20 key please remove all four (4) screws securing the socket latch mechanism (ILM) to original backplate (BP) to the motherboard. **Make sure you have install the plastic cover over the socket pins and that the socket latches are in OPEN position during this procedure!**

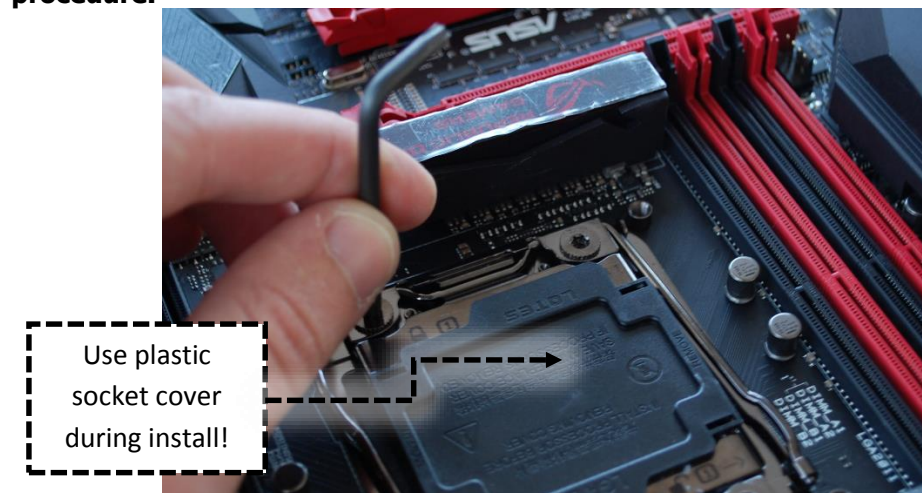

## STEP 3: INSTALLING ALTERNATIVE LGA-2011 BACKPLATE

After removing the original LGA-2011 backplate, installed on your ASUS Rampage V Extreme motherboard, it is mandatory to install the alternative LGA-2011 provided with your motherboard. Use the enclosed Torx T20 key to re-install it. **Make sure you have install the plastic cover over the socket pins and that the socket latches are in OPEN position during this procedure!** It is now a prime time to install your LGA-2011-CPU into the motherboard socket.

## STEP 4: PREPARING YOUR MOTHERBOARD

2. CLEANING THE PCB. Carefully detach the original stock cooler after removing **all** screws securing it to the board. Wipe off the remains (by using non-abrasive cloth or *qtip*, as shown on sample photo) of the original thermal compound until the components and circuit board are completely clean. EKWB recommends the use of denatured alcohol for removing TIM leftovers.

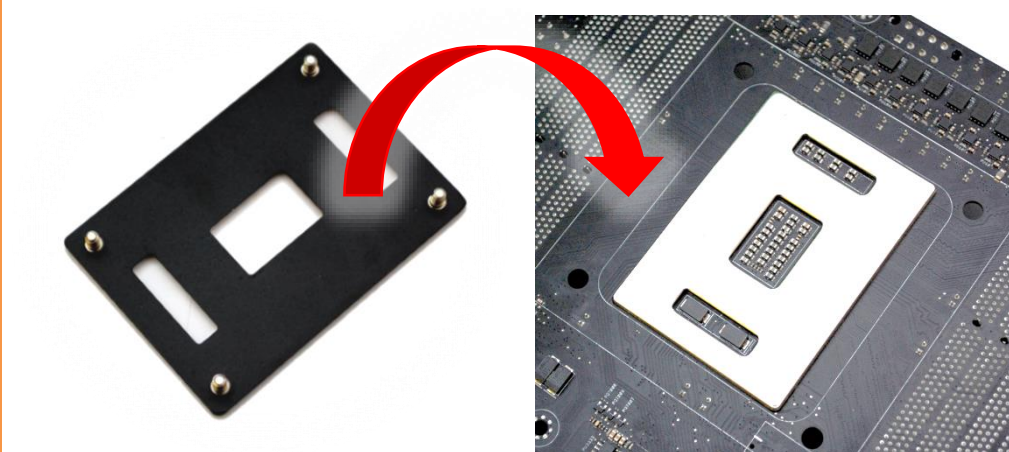
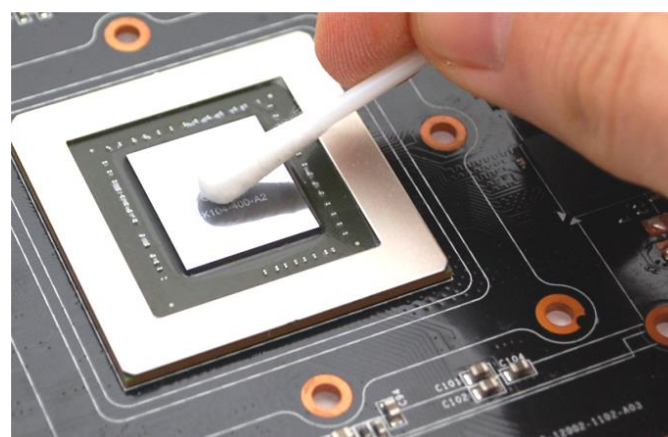

3. APPLYING THERMAL COMPOUND. Apply thermal compound: lightly coat the Intel X99 (PCH) – see sample photo on the left and CPU heat spreader (IHS) - see sample photo on right with enclosed EK-TIM Ectotherm thermal grease.

The quantity of about two rice grains is just about right. There is no need to cover the whole IHS. Applying too much thermal grease will have negative impact on the cooling performance!

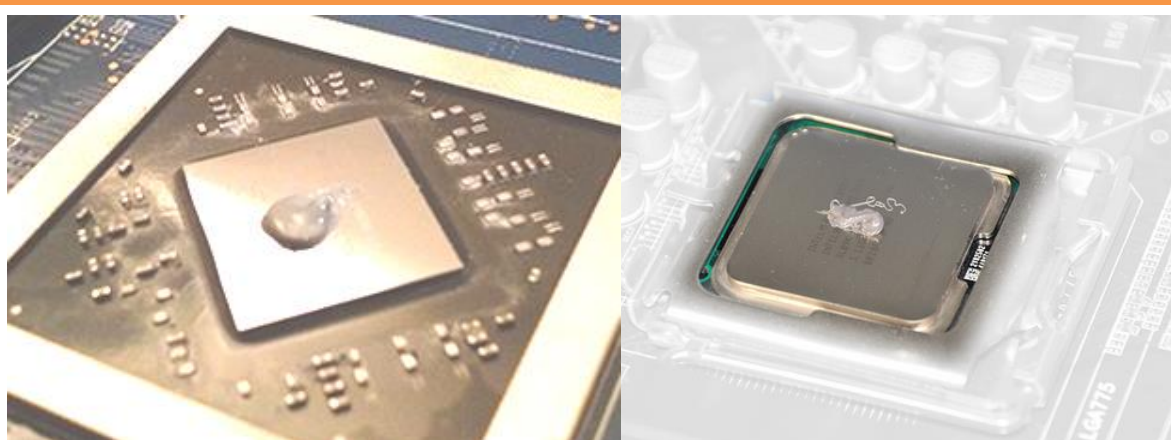



4. **CUTTING THERMAL PADS.** Your block comes with thermal pads which needs to be trimmed in order to fit the voltage regulation area (VRM/MOSFET) on the motherboard's circuit board. **WARNING: DIMENSIONS ON PICTURES BELOW ARE SCALED.**

**Replacement thermal pads @ EKWB web shop:**  
Thermal PAD A 1mm - (100x16mm) [EAN: 3830046996626]

Thermal pad A - 1.0mm  
(for inductor coils & mosfets):

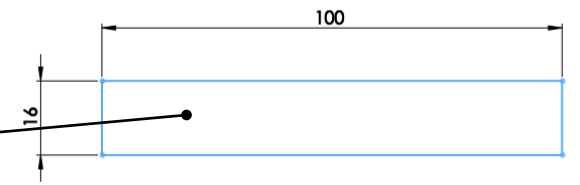

5. **PLACING THERMAL PADS ON MOTHERBOARD.** Place thermal pads you cut on PCB as shown on picture below (PLEASE REMOVE THE PROTECTIVE FOIL FROM BOTH SIDES OF THE THERMAL PADS PRIOR TO INSTALLATION). EK recommends using small drops of electrically non-conductive (for example: EK-Ectotherm, Gelid GC-Extreme, Arctic Cooling MX-2™ or MX-4™) thermal grease on each phase regulator (that is being covered with thermal pad; see picture below) in order to even further improve the thermal performance of the EK-FB ASUS R5E Monoblock series water block.

Place 1mm thermal pads in larger strips over marked area and make sure all mosfet chips (yellow) are covered.

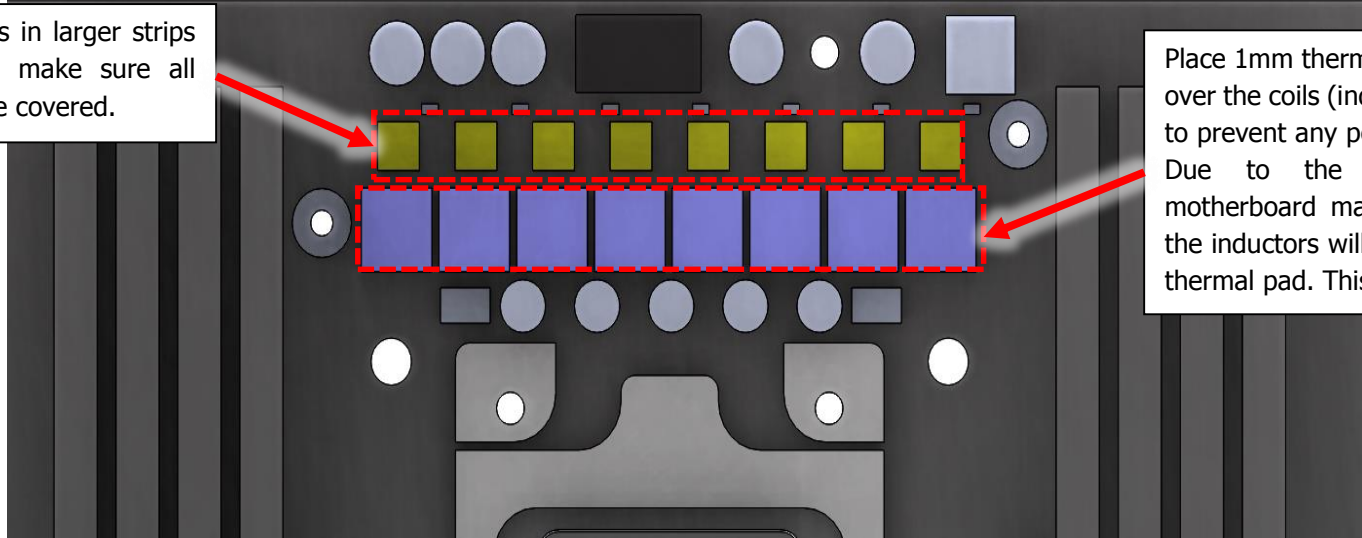

Place 1mm thermal pads in larger strips over the coils (inductors). This is merely to prevent any possible short circuiting. Due to the uneven nature of motherboard manufacturing not all of the inductors will have contact with the thermal pad. This is normal.

**STEP 5: ATTACHING THE WASHERS TO THE STANDOFFS**

1. **ATTACHING THE SELF-ADHESIVE WASHERS TO THE STANDOFFS.** Take the self-adhesive washer and peel the protective foil from the glued-side. Glue the washer on the standoff, concentric with the threaded hole (as shown on the picture below). This procedure stands for 5 (five) positions, marked in the picture below!

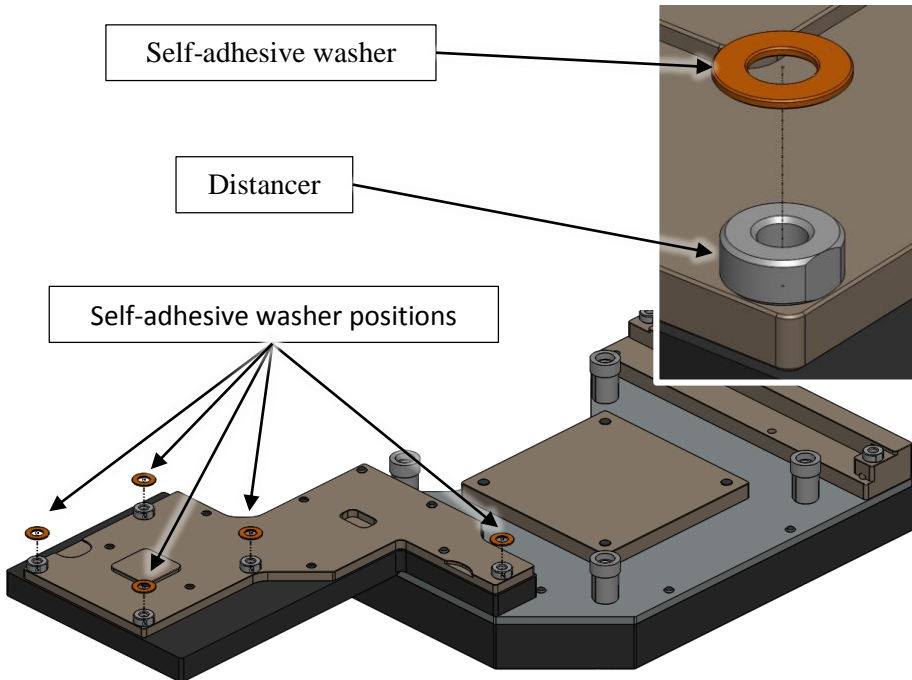

**STEP 5.1: PLACING THE BLOCK ON TO MOTHERBOARD**

2. **PLACING THE BLOCK ON THE MOTHERBOARD.** Place the EK-FB ASUS R5E Monoblock series water block gently to the motherboard or vice versa (as shown on photo below). Make sure that mounting holes are aligned.

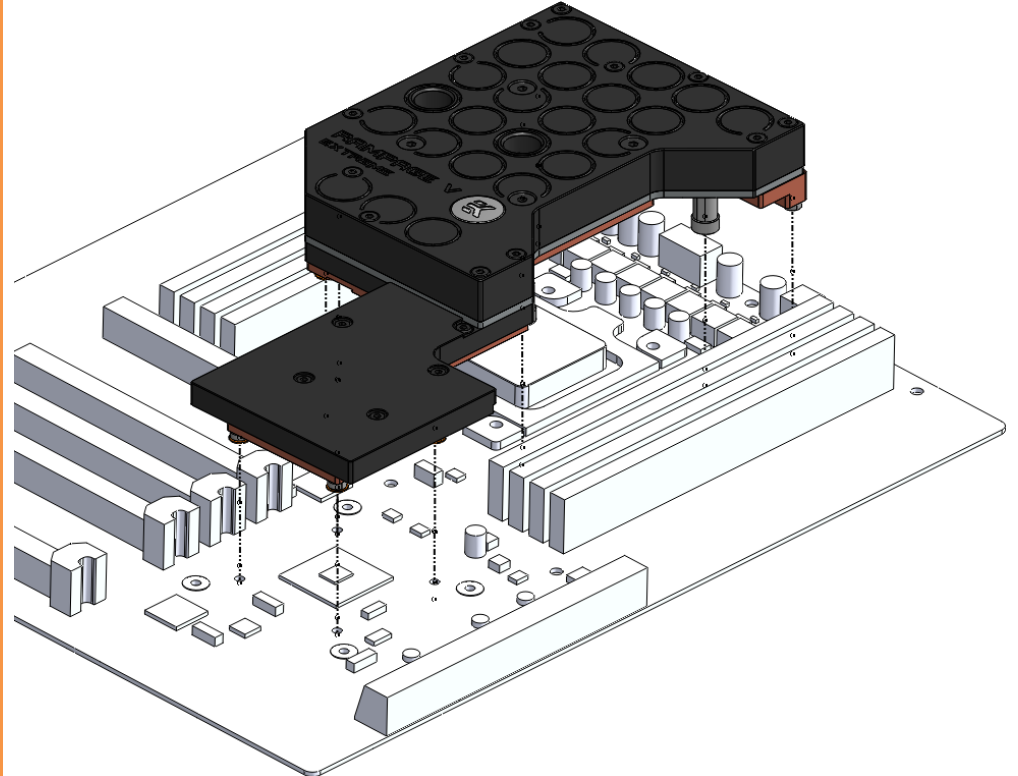

**STEP 6: ATTACHING BLOCK ON TO THE MOTHERBOARD**

Prior to fastening the screws please make sure the mounting holes on the motherboard's circuit board are aligned with the water block.

- A) **SB part:** Use five M3x5 DIN7985 and PVC washers. Tighten the screws, beginning near the south bridge, and continue evenly outwards. Do not use excessive force when tightening the screws!
- B) **MOSFET part:** Use ASUS factory ("stock") backplate and two M3x8 DIN7991 screws. Do not use excessive force when tightening the screws!
- C) **CPU part:** Use four M4x8 DIN7984 screws and washers. Tighten the screws using enclosed Alley Keys 2 and 2.5mm.

Use the enclosed screws and washers as shown in picture below:

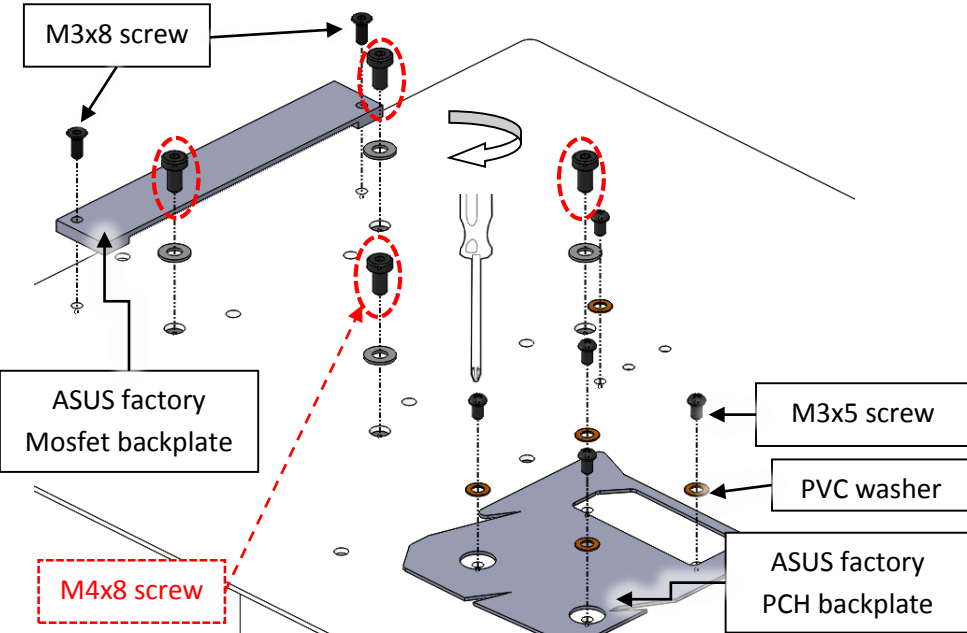

For the EK-FB ASUS R5E Monoblock series water block to operate properly the G1/4 port nearest to the center of the water block **MUST BE USED AS THE INLET PORT**. EK recommends the use of EK-CSQ fittings. When using fittings other than EK-CSQ series please use hose clamps or appropriate substitute to secure the tubing to the barb. The use of biocide containing and corrosion inhibiting coolant is always recommended for any liquid cooling system.

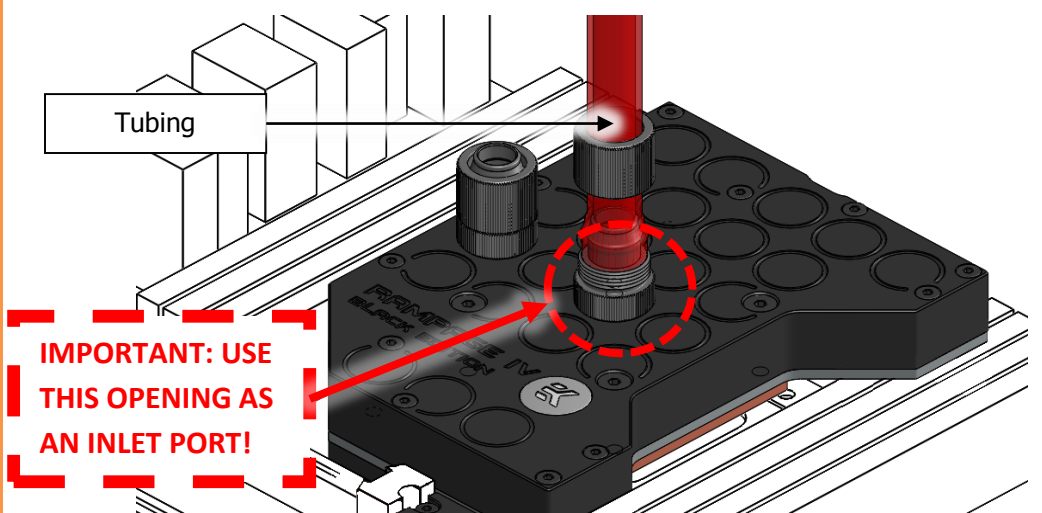

**REQUIRED TOOLS AND MOUNTING SCREWS:**

