



Installation and mounting manual for **EK-FB ASUS CROSSHAIR V** water block:

This product is intended for installation only by expert users. Please consult with a qualified technician for installation. Improper installation may result in damage to your equipment. EK Water Blocks assumes no liability whatsoever, expressed or implied, for the use of these products, nor their installation. The following instructions are subject to change without notice. Please visit our web site at www.ekwaterblocks.com for updates. Before installation of this product please read important notice, disclosure and warranty conditions printed on the back of the box or our home page.

The barb hose fittings require only a small amount of force to screw them in; otherwise the high flow fittings might break. These fittings do not need to be tightened with much force because the liquid seal is made using o-rings. The use of corrosion inhibitors is always recommended for any liquid cooling system.

STEP 1: GENERAL INFORMATION Sample photo of ASUS CROSSHAIR V FORMULA motherboard

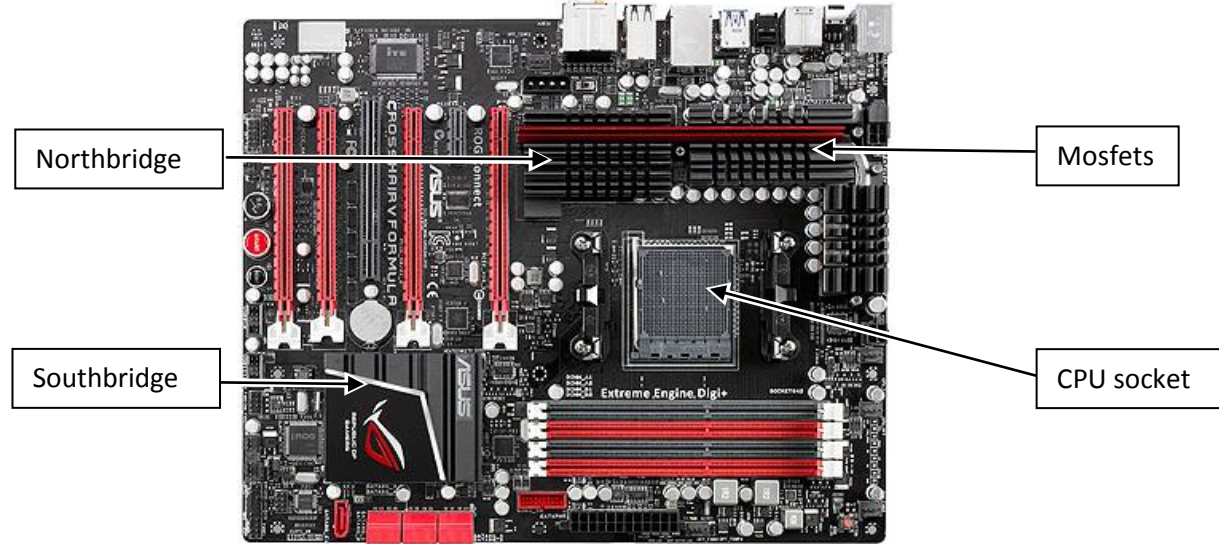

STEP 2: PREPARING YOUR MOTHERBOARD

1. REMOVING STOCK COOLER. Remove all encircled screws. NB-MOSFET cooler assembly and it's backplate must be removed. There are 4 screws on the front- and two (2) on the back of the motherboard that needs to be removed in order to remove the stock NB-MOSFET cooling solution.



2. CLEANING THE PCB. Carefully detach the original stock cooler after removing **all** screws securing it to the board. Wipe off the remains (by using non-abrasive cloth or *qtip*, as shown on sample photo) of the original thermal compound until the components and circuit board are completely clean. EKWB does not recommend using any liquids for removing TIM leftovers.



3. APPLYING THERMAL COMPOUND. Apply thermal compound: lightly coat the *AMD 990FX* (NB) chip with electrically non-conductive thermal grease - for example Arctic Cooling MX-2™ or MX-4™. EKWB recommends to apply thermal grease in cross form for best performance (see sample picture).

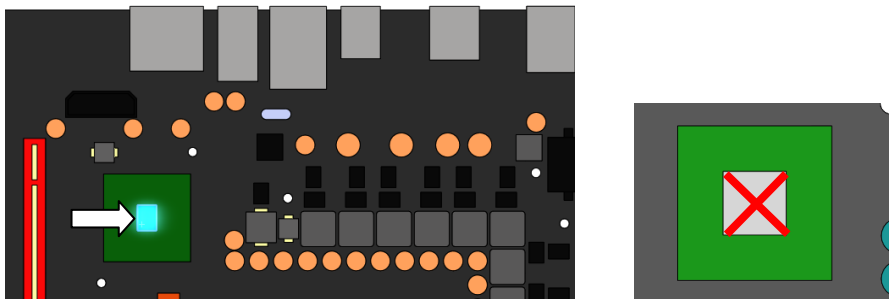

4. CUTTING THERMAL PADS. Your block comes with three (3) precut thermal pads (54x16x0.5mm). **WARNING: DIMENSIONS ON PICTURES BELLOW ARE SCALED!**

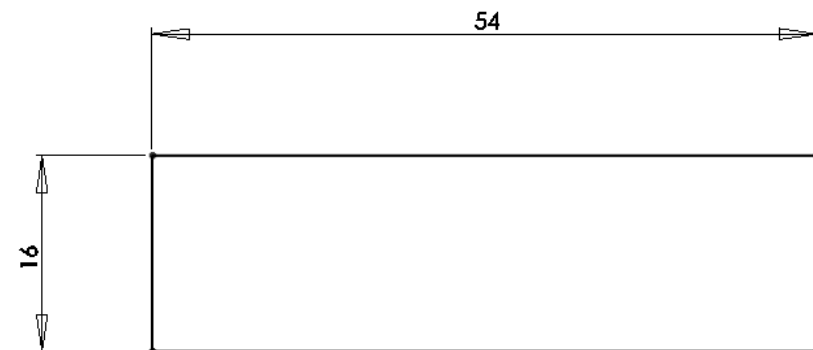

5. PLACING THERMAL PADS ON MOTHERBOARD. Place thermal pads you cut on PCB as shown on picture below. (PLEASE REMOVE THE PROTECTIVE FOIL FROM BOTH SIDES OF THE THERMAL PADS PRIOR TO INSTALLATION). EK recommends using small drops of electrically non-conductive (for example: Arctic Cooling MX-2™ or MX-4™) thermal grease on each phase regulator (that is being covered with thermal pad; see picture below) in order to even further improve the thermal performance of the EK-FB ASUS Crosshair V series water block.

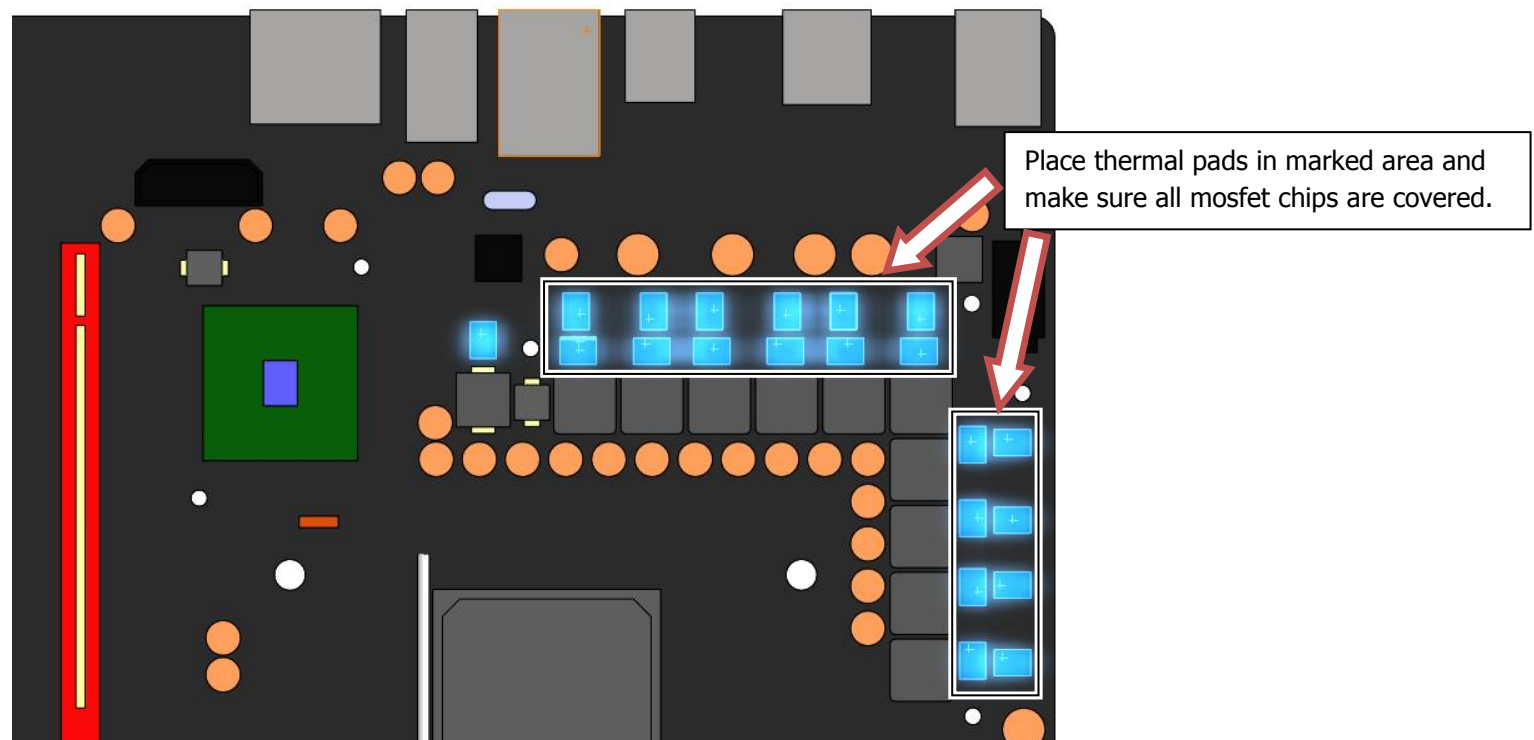

STEP 3: PREPARING YOUR WATER BLOCK

1. PLACING STANDOFFS ON BLOCK. Brass standoffs are necessary in order to attach this water block to the printed circuit board of the graphics card. Please use the enclosed key to screw them to the copper base of the water block. There is no need to overtighten standoffs as nickel plating or threads may get damaged.(also be careful with handling the key as you may scratch material).

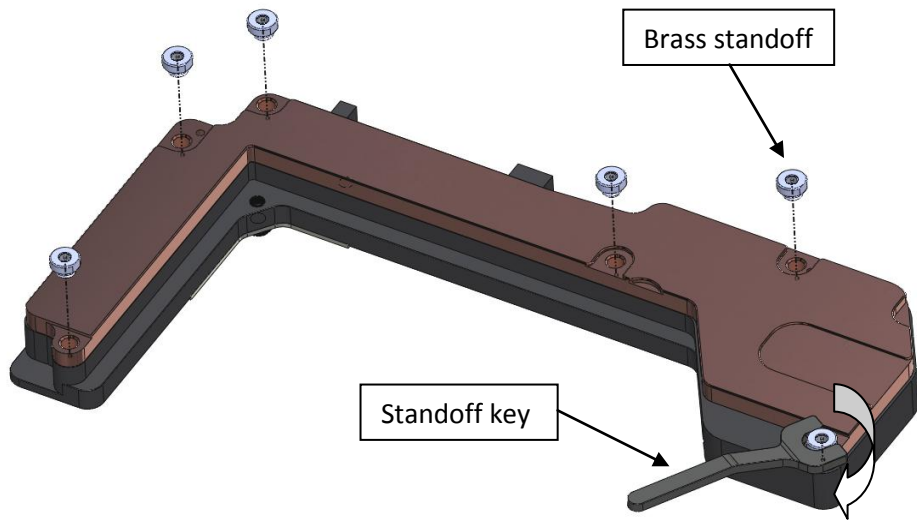

2. PLACING BLOCK ON MOTHERBOARD. Place the waterblock gently to the motherboard or vice versa. Make sure that mounting holes are aligned.

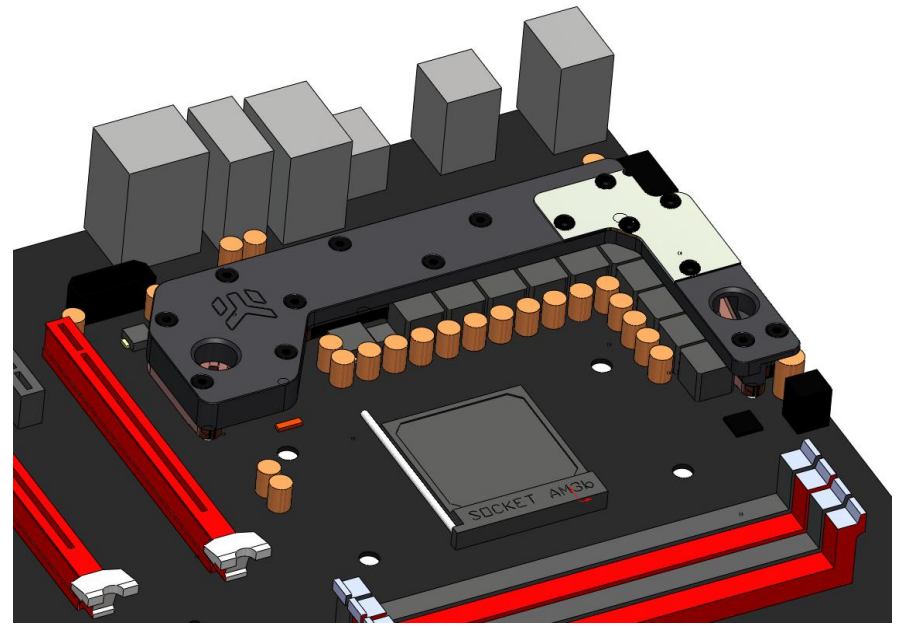

STEP 4: ATTACHING BLOCK TO MOTHERBOARD

Prior to fastening the screws please make sure the mounting holes on the motherboard's circuit board are aligned with the waterblock. Tighten the screws, beginning near the northbridge, and continue evenly outwards. Do not use excessive force when tightening the screws!
Use the enclosed screws and washers as shown in picture below:

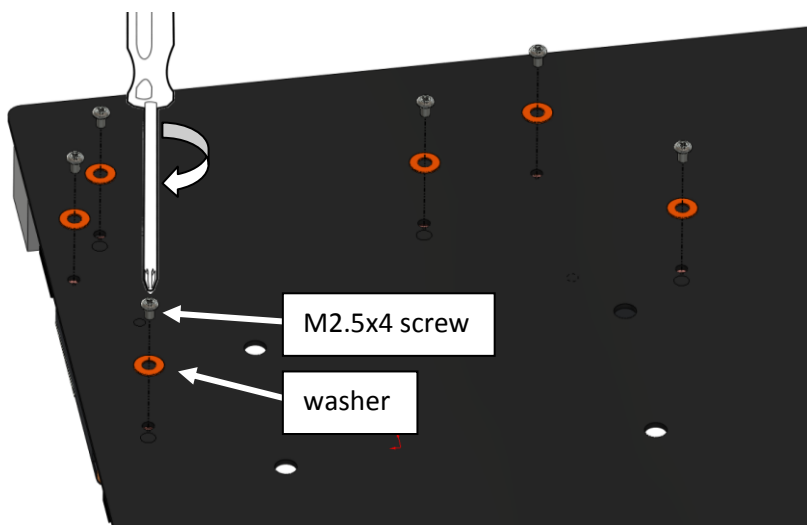

STEP 5: CHECKING FOR CONTACTS

Temporarily remove the water block to check for uniform surface contact between the block and the components. Note the pattern of contact on a piece of paper. Then repeat steps 3 and 4 to reattach the block applying more or less pressure to the areas where you have found it necessary.

6. POSITIONING FITTINGS AND CONNECTING TO WATER CIRCUIT

Please use the provided 1.8mm spacer along with the gasket on shown opening only if you use fitting with G1/4 thread longer than 5mm (see left picture). Attach the liquid cooling tubes and connect the water-block(s) into the cooling circuit. EKWB recommends using EK-PSC compression fittings with the EK-FB ASUS Crosshair V series water block. You can use any opening as an inlet/outlet port.

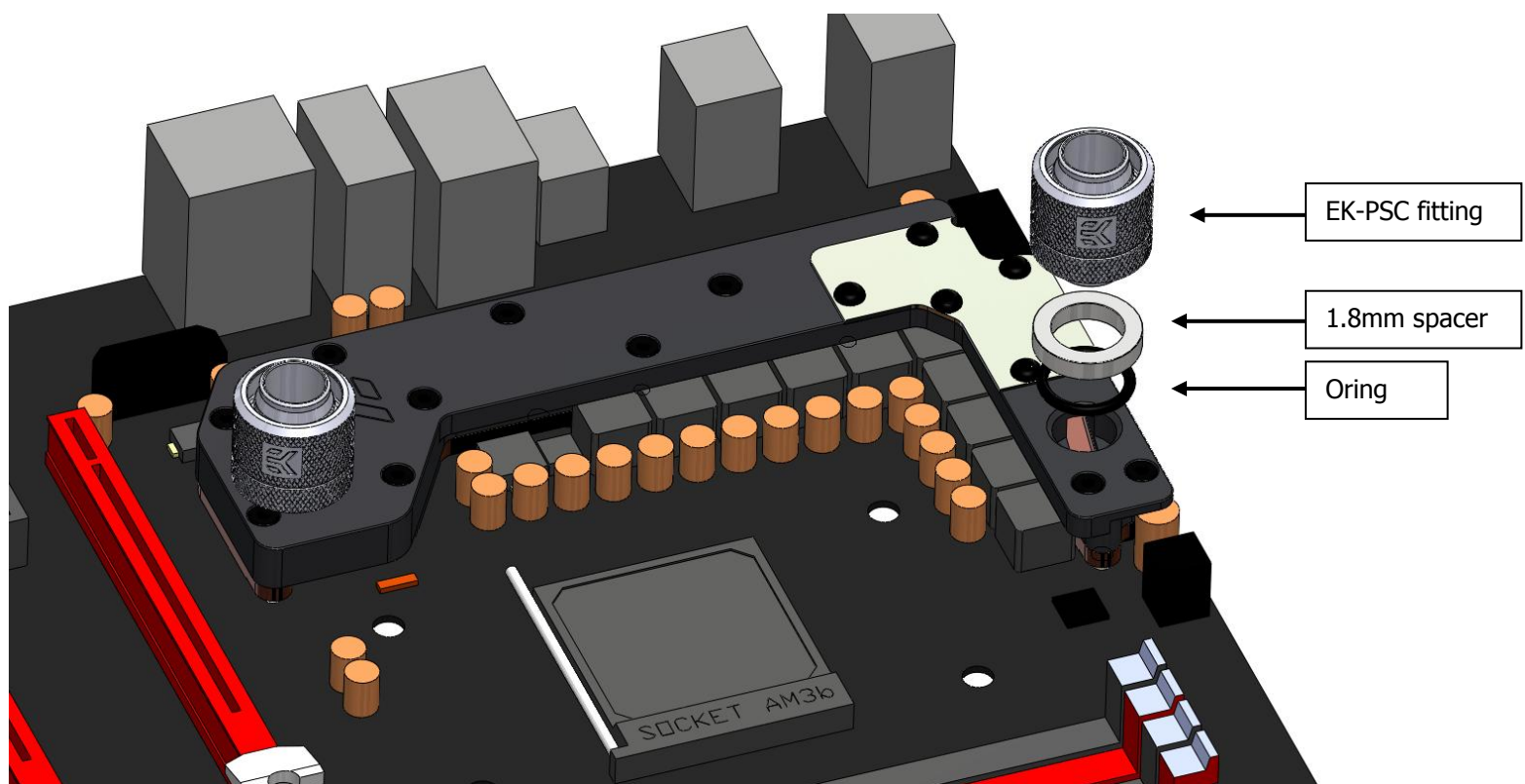

REQUIRED TOOLS AND MOUNTING SCREWS:

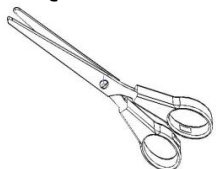

scissors



philips screwdriver

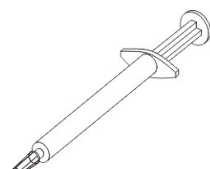

thermal grease



6x screws M2.5x4 DIN7985



6x PVC washers