

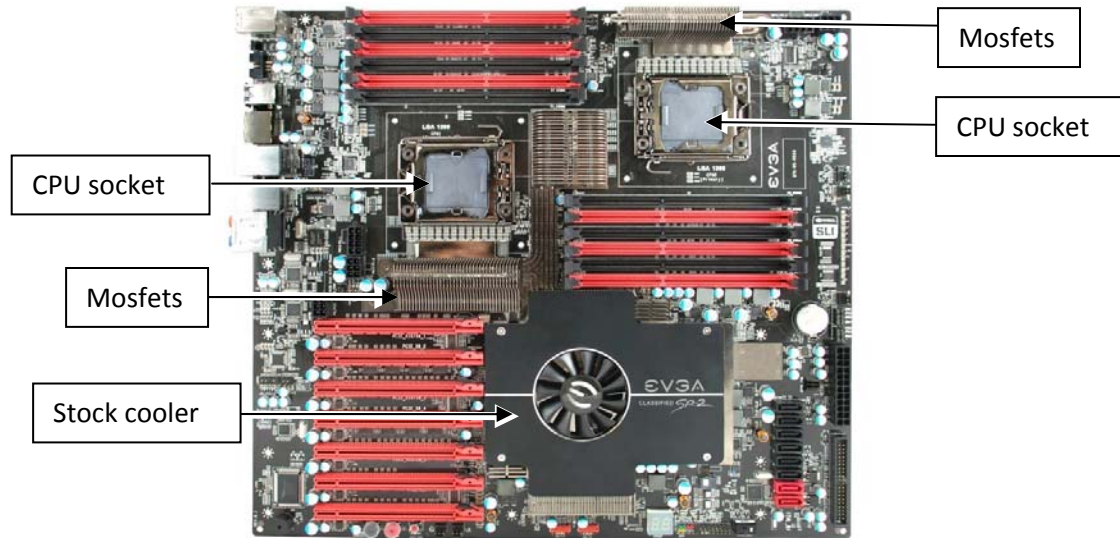

Installation and mounting manual for EK-FB SR2 water block:

This product is intended for installation only by expert users. Please consult with a qualified technician for installation. Improper installation may result in damage to your equipment. EK Water Blocks assumes no liability whatsoever, expressed or implied, for the use of these products, nor their installation. The following instructions are subject to change without notice. Please visit our web site at www.ekwaterblocks.com for updates. Before installation of this product please read important notice, disclosure and warranty conditions printed on the back of the box. **The barb hose fittings require only a small amount of force to screw them in; otherwise the high flow fittings might break. These fittings do not need to be tightened with much force because the liquid seal is made using o-rings.**

STEP 1: GENERAL INFORMATION Sample photo of EVGA SR2 CLASSIFIED PCB design



STEP 2: PREPARING YOUR MOTHERBOARD

1. REMOVING STOCK COOLER. Remove all encircled screws. All stock cooler assembly screws should be removed. There are 14 screws on the back of the motherboard.

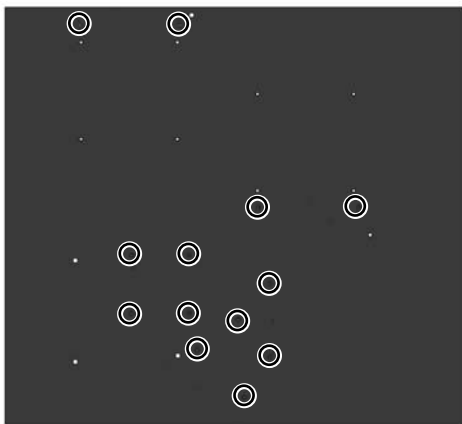

2. CLEANING THE PCB. Carefully detach the original stock cooler after removing **all** screws securing it to the board. Wipe off the remains (by using non-abrasive cloth or qtip, as shown on sample photo) of the original thermal compound until the components and circuit board are completely clean. EKWB does not recommend using any liquids for removing paste.



3. APPLYING THERMAL COMPOUND

Apply thermal compound: put a small drop of thermal compound on the chips marked in substep 5. For example Céramique™ thermal compound. Follow this link http://www.arctic-cooling.com/catalog/product_info.php?cPath=39&mID=127&language=en for detailed instructions. EKWB recommends non-conductive MX-2, which should be applied in cross form for best performance (see sample picture).

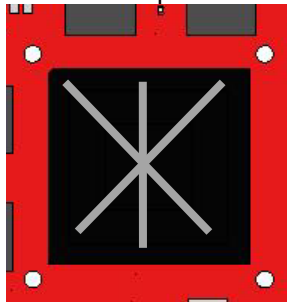

4. CUTTING THERMAL PADS. Three types of thermal pads are enclosed with your water block. (WARNING: DIMENSIONS ON PICTURES BELLOW ARE SCALED!)

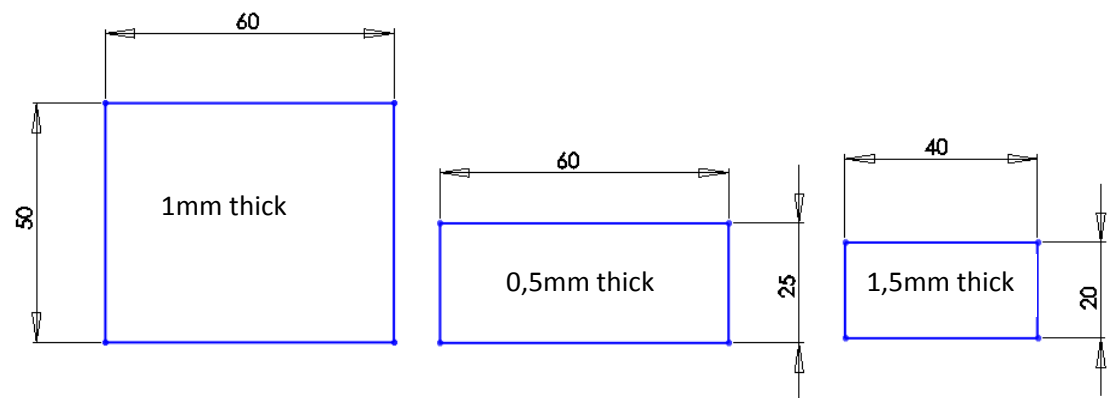

5. PLACING THERMAL PADS ON MOTHERBOARD. Place thermal pads you cut on PCB as shown on picture bellow. (PLEASE REMOVE FOIL OF THERMAL PADS PRIOR TO INSTALLATION.)

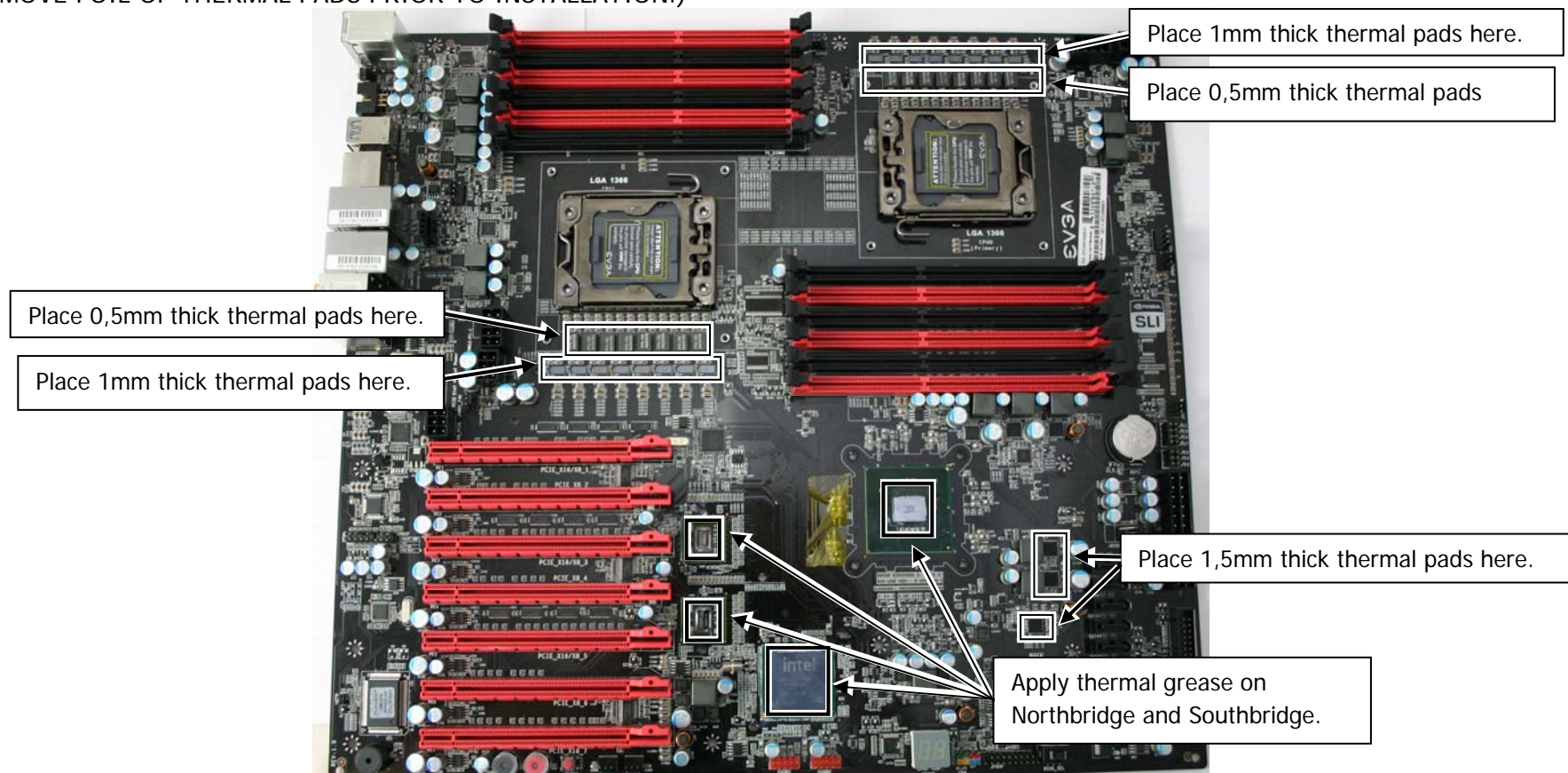

STEP 3: PREPARING YOUR WATER BLOCK

1. ATTACHING STANDOFFS. Apply small amount of thermal grease around mounting holes (FB and separated mosfet block) and place acetal standoffs (thickness 2,1 mm) so the holes are concentric. Thermal paste provides enough adhesive force for standoffs to stay in a place.

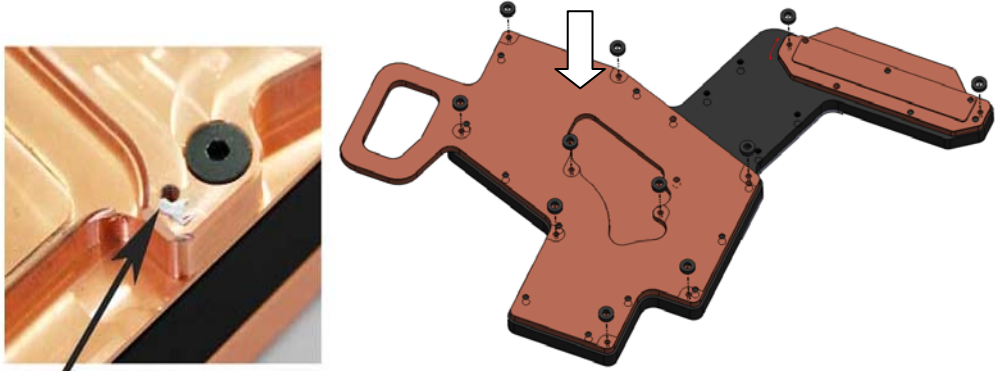

2. PLACING BLOCK OVER GPU. Place the motherboard on the inverted water block(s) or vice versa and attach them one at the time with enclosed screws as shown in step 4 and 5. Make sure that mounting holes are aligned.

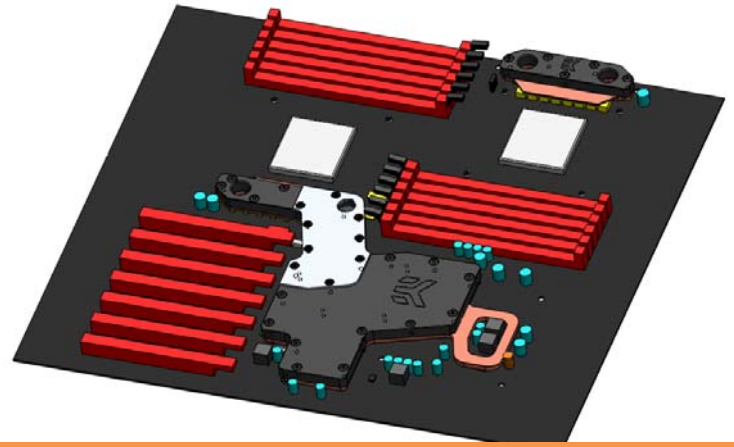

STEP 4: ATTACHING FB BLOCK TO MOTHERBOARD

1. MOUNTING THE BLOCK.

Tightening the screws beginning in the center of the block near the northbridge, and continue evenly outwards. Do not use too much pressure on screws, because motherboard might bend and either cause bad contact with water block, or break a connection on the board.

Use the enclosed screws and washers as shown in diagram below:

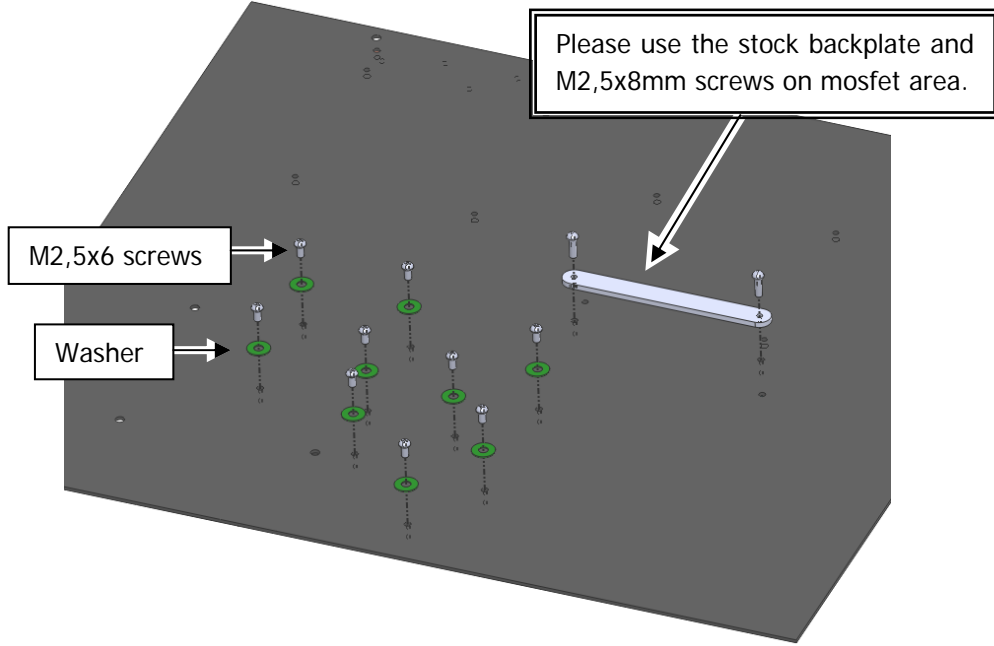

STEP 5: ATTACHING MOSFET BLOCK TO MOTHERBOARD

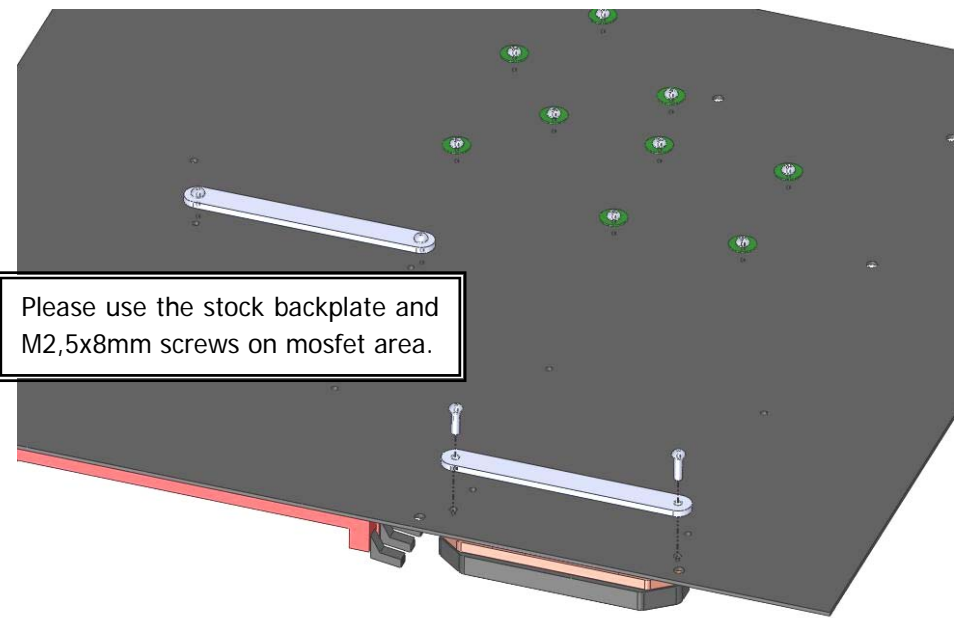

6. POSITIONING FITTINGS AND CONNECTING TO WATER CIRCUIT

Please use enclosed spacer on shown (see sample picture). Attach the liquid cooling tubes and connect the water-block(s) into the cooling circuit. EKWB recommends using high flow fittings with the EK-FB SR2 series water blocks. To ensure that the tubes are securely attached to the barb/fittings, please use hose clamps or an appropriate substitute. The use of an algacide is always recommended for any liquid cooling system.

You can use any hole as an inlet/outlet hole.

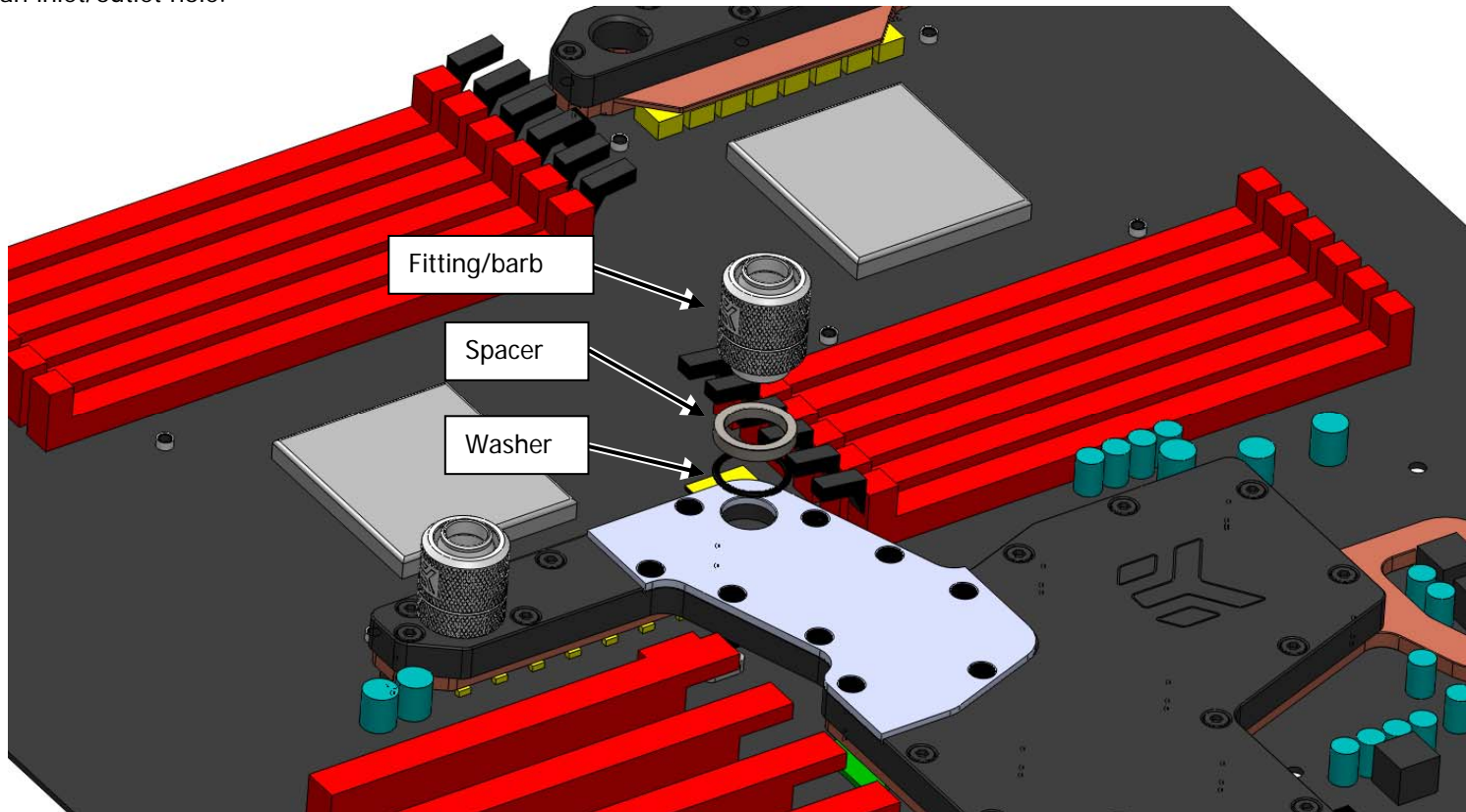

STEP 7: CHECKING FOR CONTACTS

Temporarily remove the water block to check for uniform surface contact between the block and the components. Note the pattern of contact on a piece of paper. Then repeat steps 3 and 5 to reattach the block applying more or less pressure to the areas where you have found it necessary.

REQUIRED TOOLS AND MOUNTING SCREWS:



scissors



philips screwdriver



9 screws M2,5 x 6 DIN7985



4 screws M2,5 x 8 DIN7985