

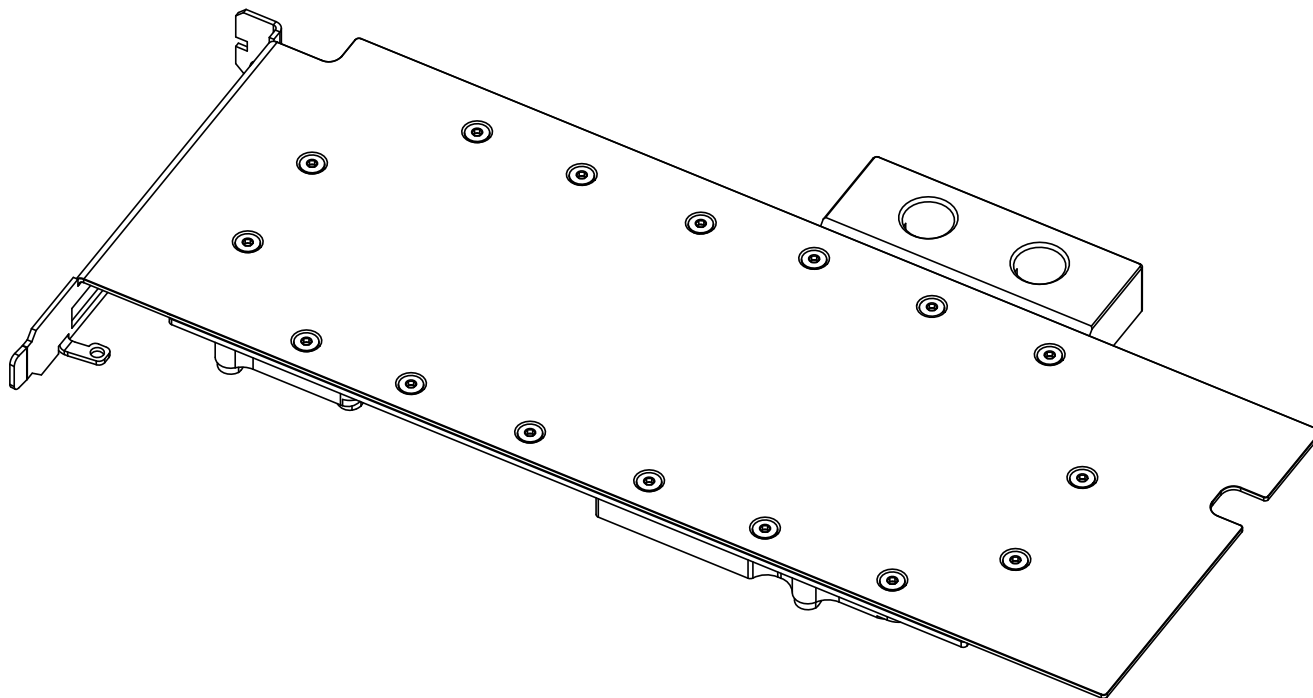

EK-FC GV100 PRO

GPU WATER BLOCK



INSTALLATION MANUAL

This product is compatible with Nvidia Quadro GV100 graphic card. It is intended for installation only by expert users. Please consult with a qualified technician for installation. Improper installation may result in damage to your equipment. EK Water Blocks assumes no liability whatsoever, expressed or implied, for the use of these products, nor their installation. The following instructions are subject to change without notice. Please visit our web site at www.ekwb.com for updates. Before installation of this product please read important notice, disclosure and warranty conditions printed on the back of the box.

Before you start using this product please follow these basic guidelines:

Please carefully read the manual thoroughly before beginning with the installation process!

Please remove your graphics card from computer to assure safest mounting process in order to prevent any possible damages to your GPU and/or graphics card circuit board(PCB).

The EK fittings require only a small amount of force to screw them firmly in place since the liquid seal is ensured by the rubber O-ring gaskets.

Do not use pure distilled water! For best results EK recommends the use of EK-CyroFuel coolants!

TABLE OF CONTENT

| | |
|--|-----------|
| PREPARING YOUR GRAPHICS CARD | 4 |
| INSTALLING THE WATER BLOCK | 6 |
| CHECKING FOR CONTACTS | 8 |
| INSTALLATION OF FITTINGS AND TUBING | 8 |
| INSERTING THE CARD IN YOUR PC CASE | 9 |
| REQUIRED TOOLS | 9 |
| SUPPORT AND SERVICE | 10 |
| SOCIAL MEDIA | 10 |

PREPARING YOUR GRAPHICS CARD

STEP 1 REMOVING THE STOCK COOLER

Remove all encircled screws using Phillips screwdriver. All heat sink assembly screws should be removed, including self-adhesive washers on both sides of the PCB (if present). Also remove encircled screws on the IO bracket.

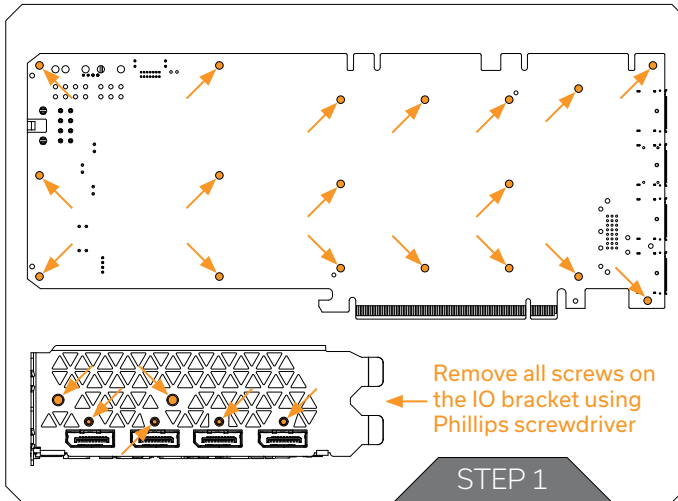

STEP 2 CLEANING THE PCB

Carefully detach the original stock cooler after removing all screws securing in to the board. Wipe off the remains (by using non-abrasive cloth or q-tip, as shown on sample photo) of the original thermal compound until the components and circuit board are completely clean. EKWB recommends the use of denatured alcohol for removing TIM leftovers.

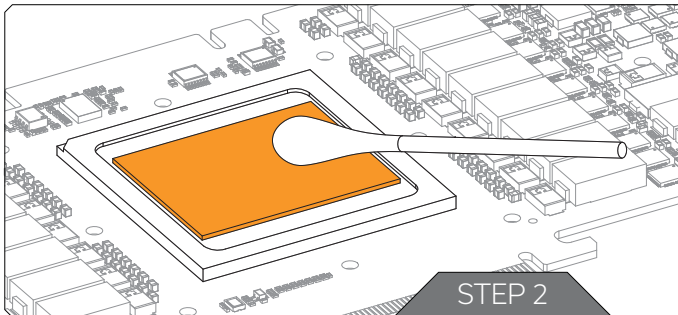

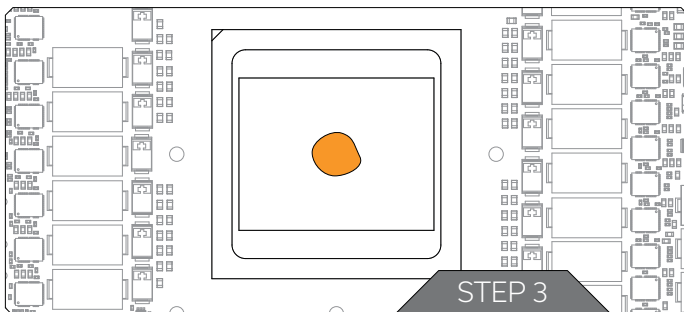

STEP 3 APPLYING THERMAL COMPOUND

Wipe off the remains (by using non-abrasive cloth or q-tip) of the original thermal compound until the components and circuit board are completely clean.

Apply thermal compound: lightly coat GPU chip with enclosed EK-TIM Ectotherm thermal grease. EKWB recommends to apply thermal grease in cross form for best performance (see sample photo).

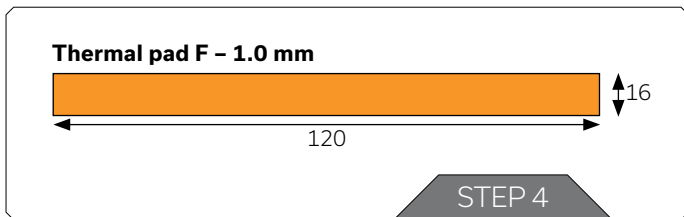

STEP 4 CUTTING THERMAL PADS

Your block comes with thermal pad (F=1.0mm) which needs to be cut to smaller chunk in order to cover all the VRM components such as MOSFETs, IC memory and coils.

PLEASE REMOVE THE PROTECTIVE FOIL FROM BOTH SIDES OF THE THERMAL PADS PRIOR TO INSTALLATION.

Replacement thermal pads:
1. Thermal PAD F 1.0mm - (120x16mm) - (EAN: 3830046996732)

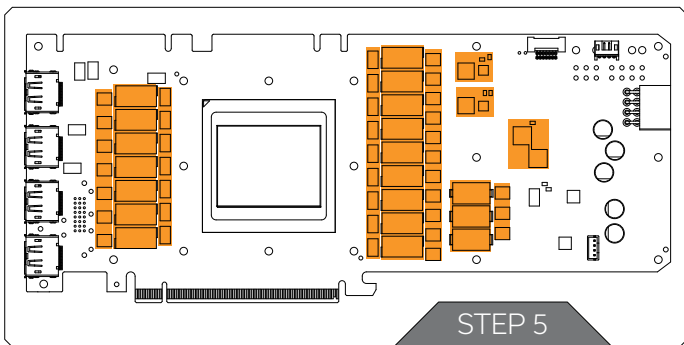

STEP 5 PLACING THERMAL PADS ON PCB

Place thermal pads on the circuit board as shown in the picture below. Refer to numbering in previous picture when applying thermal pads of different sizes or thickness. EK made sure to provide customers with more than adequate quantity of thermal pads to complete this step.

INSTALLING THE WATER BLOCK

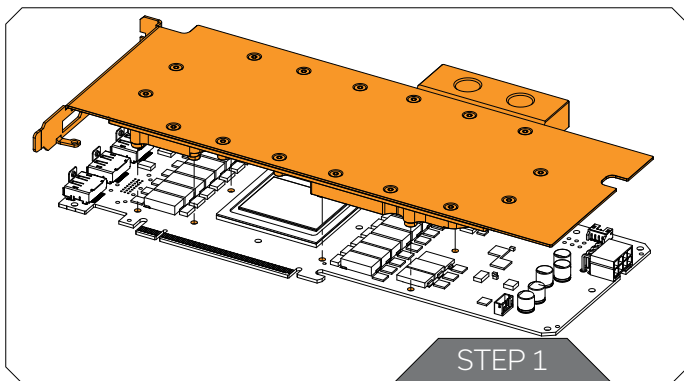

STEP 1 PLACING THE BLOCK ON TO THE GRAPHICS CARD

Carefully position the water block with preinstalled standoffs on to the graphics card. During this process please make sure you align mounting holes on the PCB with holes on the water block (same applies for other tops). Also pay attention not to use too much force by pressing the block down to the PCB. Chip dies are prone to cracking.

BAG CONTENT

Bag content is universal for all water blocks, you may not need all screws

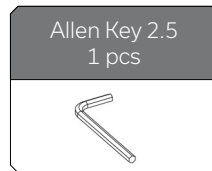
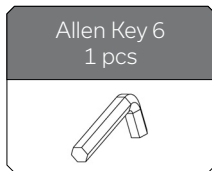
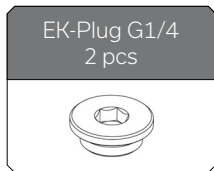
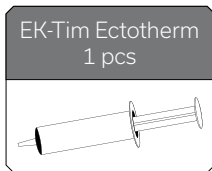
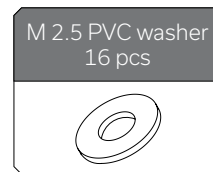
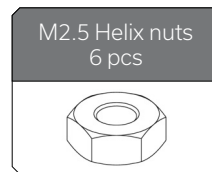
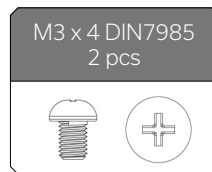
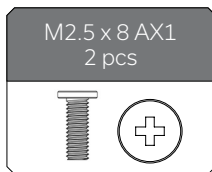
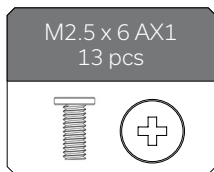
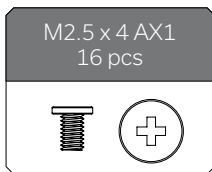

STEP 2 ATTACHING THE BLOCK TO THE GRAPHIC CARD

Use a Phillips screwdriver screw with the enclosed M2.5x4 AX1 screws. EKWB recommends users to start tightening the screws around the GPU core and continue outwards. Always use a plastic washer under each and every screw! If the washer is already present on the circuit board there is no need for additional washer.

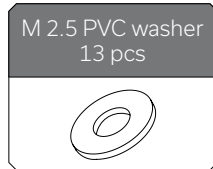
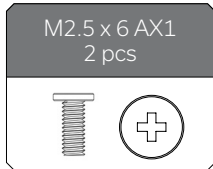
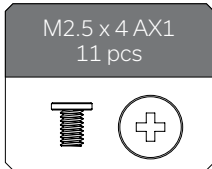
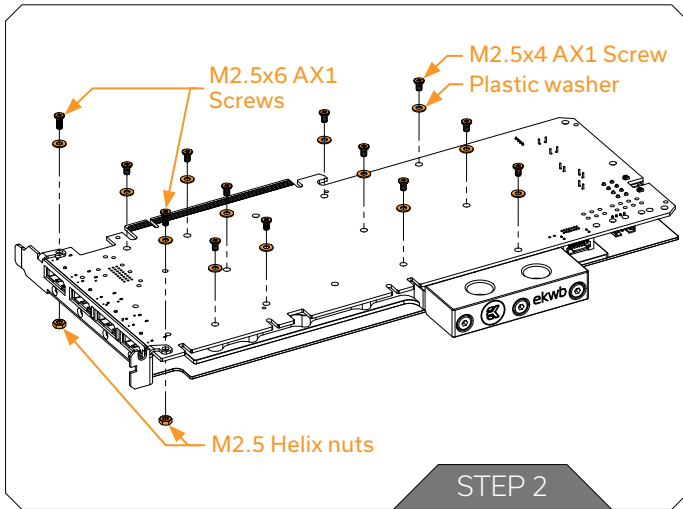

CHECKING FOR CONTACTS

If necessary temporarily remove the water block to check for uniform surface contact between the block and the components, pay special attention to the VRM section of the graphics card. Check whether the water block makes contact with the intended integrated circuit. Then repeat sub-steps in previous section to re-attach the block.

In case you fail to obtain good contact, please check again that your thermal pad thickness or contact our support service at <http://www.ekwb.com/support>.

INSTALLATION OF FITTINGS AND TUBING

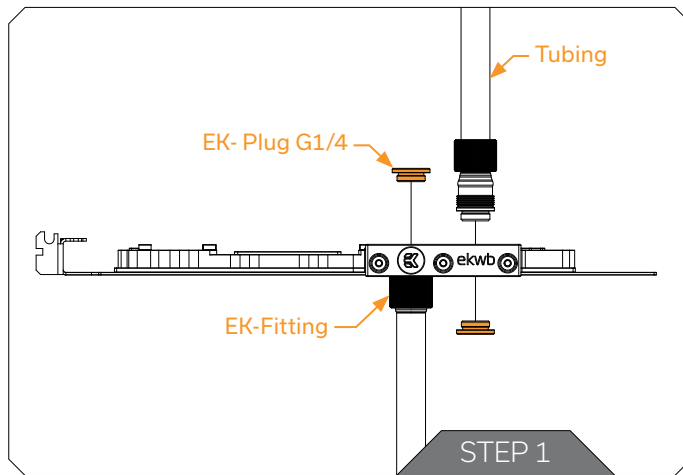

STEP 1

Screw in the two G1/4 threaded male fittings. Attach the liquid cooling tubes and connect the water-block(s) into the cooling circuit. EKWB recommends using EK- fittings.

You can use any opening as an inlet/outlet port. Do not forget to plug the remaining two opening with enclosed EK-Plug G1/4 or equivalent.

CAUTION: In case of using connectors other than EK- series compression fittings, take special attention to the length of the fittings' male G1/4" thread. 5mm is the maximum allowed G1/4" thread length!

INSERTING THE CARD IN YOUR PC CASE

Carefully lift your graphics card with installed block and insert it in your PC's motherboard PCI express expansion slot. Please bear in mind that your graphics card is probably heavier than when it was equipped with original heat sink fan assembly. One needs to be very careful when handling the graphics card. Avoid all un-needed manipulation of the VGA/water block assembly that might damage your card or water block during final installation.

REQUIRED TOOLS

Phillips-head screwdriver

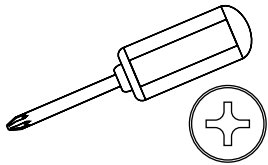

Scissors

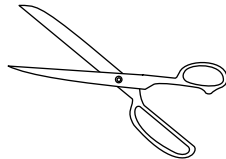

SUPPORT AND SERVICE

For assistance please contact:

<http://support.ekwb.com/>

EKWB d.o.o.
Pod lipami 18
1218 Komenda
Slovenia - EU

SOCIAL MEDIA

 EKWaterBlocks

 @EKWaterBlocks

 ekwaterblocks

 EKWBofficial

 ekwaterblocks

