

This product is intended for installation only by expert users. Please consult with a qualified technician for installation. Improper installation may result in damage to your equipment. EK Water Blocks assumes no liability whatsoever, expressed or implied, for the use of these products, nor their installation. The following instructions are subject to change without notice. Please visit our web site at www.ekwb.com for updates. Before installation of this product please read important notice, disclosure and warranty conditions printed on the back of the box.

Before you start using this product please follow these basic guidelines:

1. Please carefully read the manual before through before beginning with the installation process!
2. Please remove your Graphics card from the computer to assure safest mounting process in order to prevent any possible damages to your GPU and/or graphics card circuit board (PCB).
3. The EK-HFB and EK-ACF type fittings require only a small amount of force to screw them firmly in place since the liquid seal is ensured by the rubber O-ring gaskets.
4. The use of corrosion inhibiting coolants is always recommended for any liquid cooling system.

BAG CONTENT: Bag content is universal for all water blocks, you may not need all screws.

| | | | | |
|------------|------------|------------|--------------|----------------|
| | | | | |
| M2.5x4 AX1 | M2.5x6 AX1 | M2.5x8 AX1 | M3x4 DIN7985 | M2.5 helix nut |
| 16pcs | 13pcs | 2pcs | 2pcs | 6pcs |

| | | | | |
|--|----------------|--------------|---------------|-----------------|
| | | | | |
| PVC Washer | Thermal grease | EK plug G1/4 | 6mm Allen key | 2.5mm Allen key |
| 16pcs | 1pc | 2pcs | 1pc | 1pc |
| Replacement mounting mechanism: FC - Tip F (M2,5 x AX1) (EAN: 3831109872215) | | | | |

STEP 1: PREPARING YOUR GRAPHIC CARD

1. REMOVING FACTORY PROVIDED BACKPLATE. Remove all encircled screws. All heat sink assembly screws should be removed, including self-adhesive washers on both sides of the PCB (if present). Also remove encircled screws on the IO bracket using Phillips screwdriver.

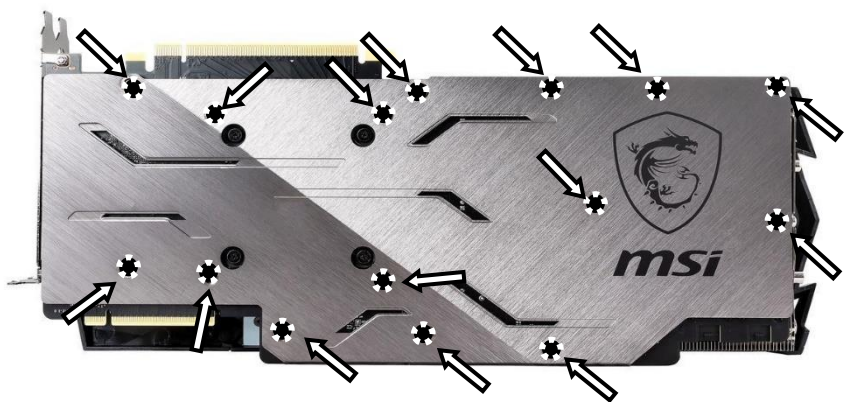

STEP 1 cont.: PREPARING YOUR GRAPHIC CARD.

2. REMOVING STOCK COOLER: Remove all encircled screws using Phillips screwdriver. All heat sink assembly screws should be removed, including self-adhesive washers on both sides of the PCB (if present). After you remove the housing do not forget to unplug the fans.

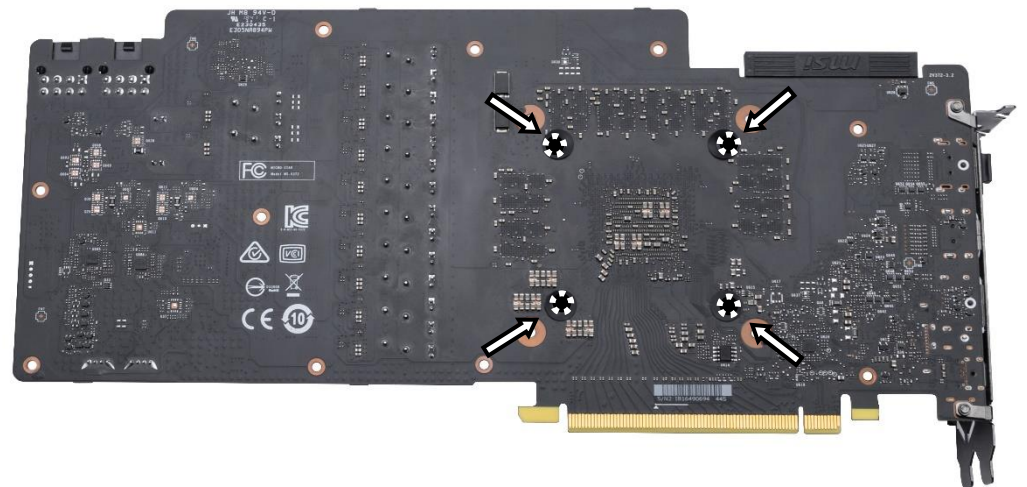

STEP 1 cont.: PREPARING YOUR GRAPHIC CARD

1. CLEANING THE PCB: Carefully detach the original stock cooler after removing all screws securing it to the board. Wipe off the remains (by using non-abrasive cloth or *q-tip*, as shown on sample photo) of the original thermal compound until the components and circuit board are completely clean. EKWB recommends the use of denatured alcohol for removing TIM leftovers.

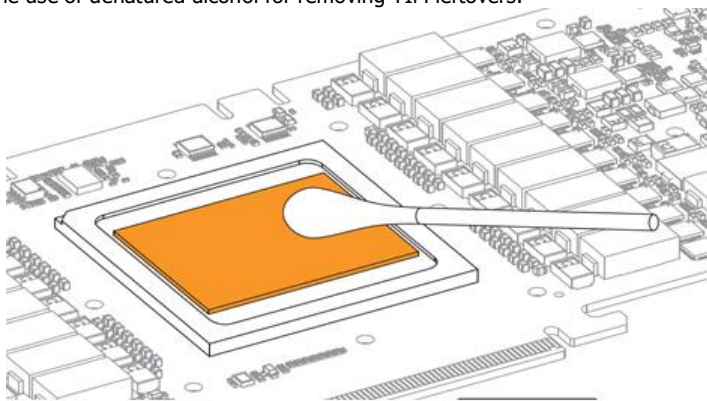

2. APPLYING THERMAL COMPOUND: Wipe off the remains (by using non-abrasive cloth or *q-tip*) of the original thermal compound until the components and circuit board are completely clean. Apply thermal compound: lightly coat *NVIDIA* GPU chip with enclosed EK-TIM Ectotherm thermal grease. EKWB recommends to apply thermal grease in cross form for best performance (see sample picture).

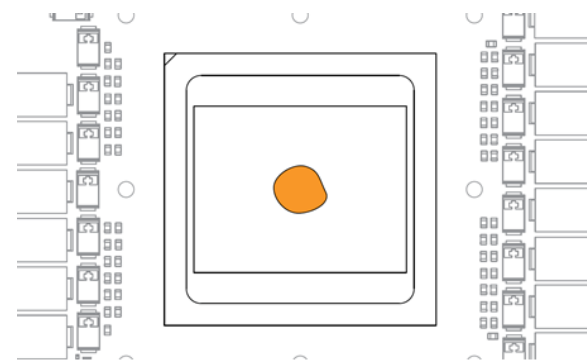

3. CUTTING THERMAL PADS: Your block comes with thermal pads, some of which are already pre-cut. Others have to be cut to smaller chunks in order to cover all the VRM components such as MOSFETS and drivers. PLEASE REMOVE THE PROTECTIVE FOIL FROM BOTH SIDES OF THE THERMAL PADS PRIOR TO INSTALLATION.

Replacement thermal pads:

Thermal Pad E – 0.5mm (RAM 8x) – (EAN: 3830046996688)
Thermal Pad G – 1mm (120x24mm) – (EAN: 3830046996770)

1: Thermal pad E – 0.5mm
(for memory IC):

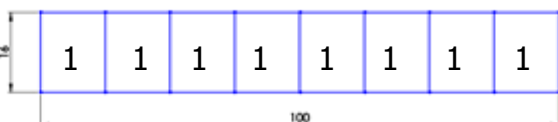

2: Thermal pad G – 1mm
(for Mosfet):

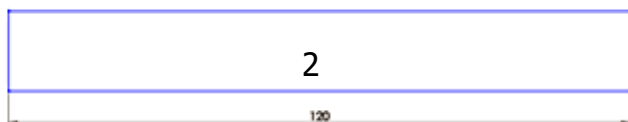

4. PLACING THERMAL PADS ON PCB. Place thermal pads on the circuit board as shown on the picture below. Refer to numbering in previous picture when applying thermal pads of different sizes or thicknesses. EK made sure to provide customers with more than adequate quantity of thermal pads to complete this step.

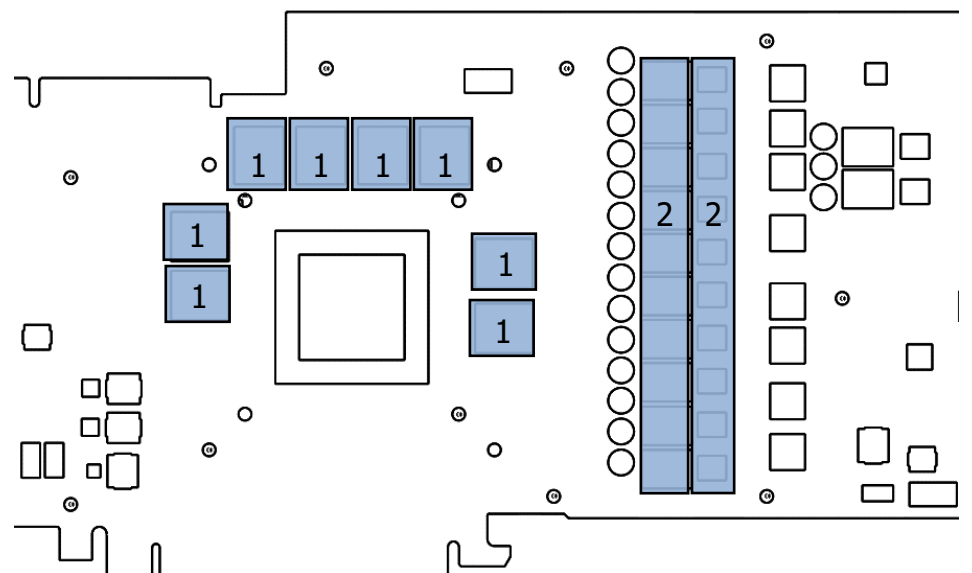



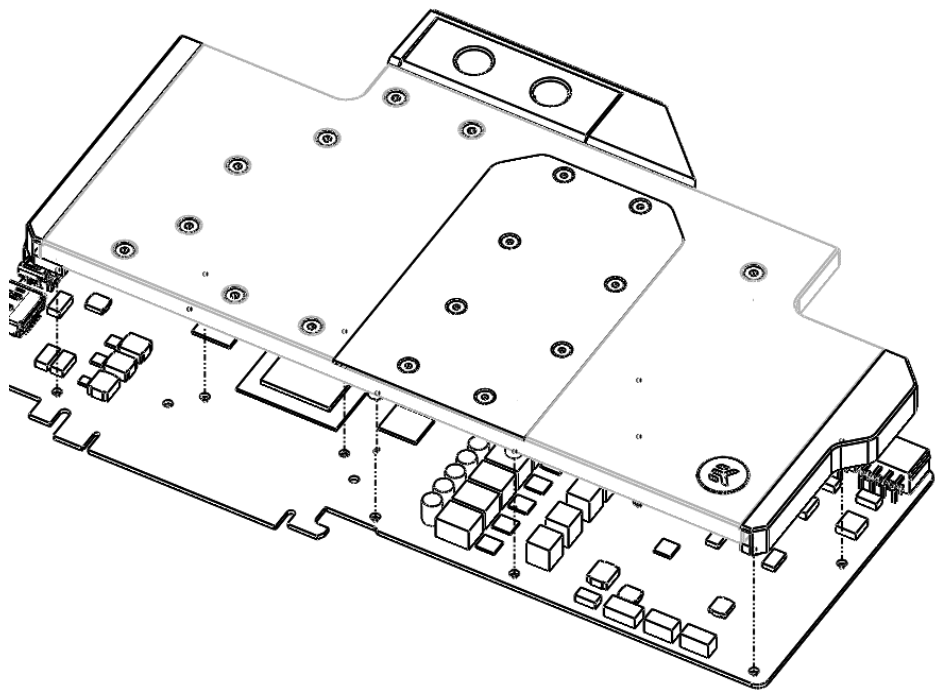

STEP 2: INSTALLING THE WATER BLOCK

1. **PLACING THE BLOCK ON TO THE GRAPHICS CARD.** Carefully position the water block with preinstalled standoffs on to the graphics card. During this process please make sure you align mounting holes on the PCB with holes on the water block (same applies for other tops). Also pay attention not to use too much force by pressing the block down to the PCB. Chip dies are prone to cracking.

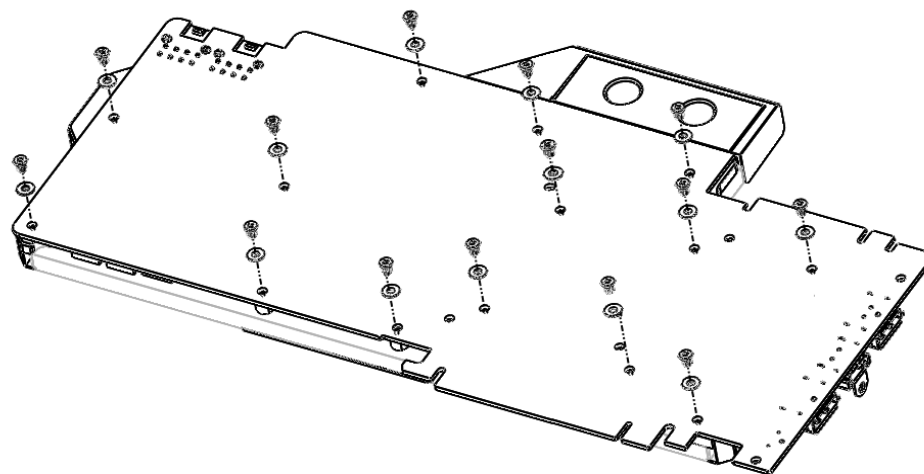

2. **ATTACHING THE BLOCK TO THE GRAPHIC CARD.** Use a Philips screwdriver screw with the enclosed M2,5x4 AX1 (14) screws. EKWB recommends users to start tightening the screws around the GPU core and continue outwards. Always use a plastic washer under each and every screw! If the washer is already present on the circuit board (usually around the four GPU core screw holes) there is no need for additional washer.



| In this step you will need: | | |
|---|---|---|
|  |  |  |
| Philips head screwdriver | M2.5x4 AX1 14pcs | M2.5 PVC washer 14pcs |

STEP 3: CHECKING FOR CONTACTS

If necessary temporarily remove the water block to check for uniform surface contact between the block and the components, pay special attention to the VRM section of the graphics card. Check whether the water block makes contact with the intended integrated circuit. Then repeat sub-steps in previous section to re-attach the block. **In case you fail to obtain good contact, please check again that your thermal pad thickness or contact our support service at <http://www.ekwb.com/support>.**

STEP 4: INSTALLATION OF FITTINGS AND TUBING

Screw in the two G1/4 threaded male fittings. Attach the liquid cooling tubes and connect the water-block(s) into the cooling circuit. **EKWB recommends using EK-ACF fittings with the EK-Vector Trio RTX 2080 series water blocks.** To ensure that the tubes are securely attached to the barb/fittings, please use hose clamps or an appropriate substitute.

You can use any opening as an inlet/outlet port. Do not forget to plug the remaining two opening with enclosed EK-Plug G1/4 or equivalent.

CAUTION: In case of using connectors other than EK-ACF series compression fittings, take special attention to the length of the fittings' male G1/4" thread. 5mm is the maximum allowed G1/4" thread length!

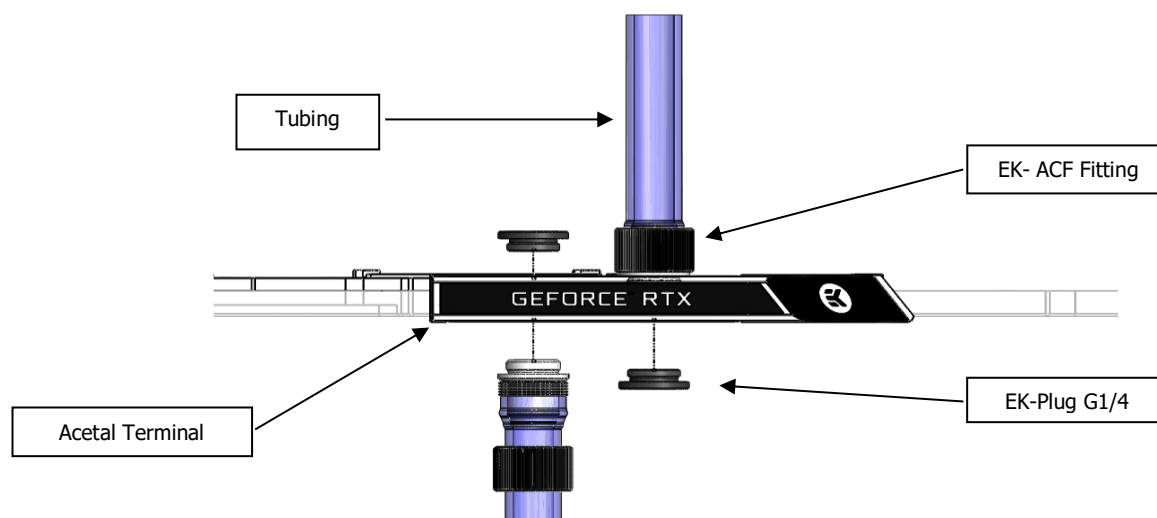

STEP 5: INSERTING THE CARD IN YOUR PC CASE

Carefully lift your graphics card with installed block and insert it in your PC's motherboard PCI-express expansion slot. Please bear in mind that your graphics card is probably heavier than when it was equipped with original heat sink fan assembly. One needs to be very careful when handling the graphics card. Avoid all un-needed manipulation of the VGA/water block assembly that might damage your card or water block during final installation.

STEP 6: CONNECTING THE RGB LED STRIP

Plug the 4-pin connector from Water block's RGB LED light to the RGB_HEADER on the motherboard. The LED will work if the pin layout on the header is as follows: **+12V G R B**.

Please ensure that the arrow indicated on the connector is plugged into the +12V line as indicated on your motherboard.

Failure to do so will damage your motherboard or LED strip.

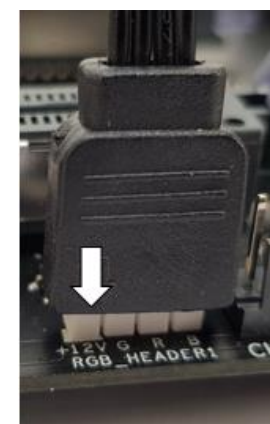

REQUIRED TOOLS:



scissors

Philips head screwdriver