

This product is intended for installation only by expert users. Please consult with a qualified technician for installation. Improper installation may result in damage to your equipment. EK Water Blocks assumes no liability whatsoever, expressed or implied, for the use of these products, nor their installation. The following instructions are subject to change without notice. Please visit our web site at www.ekwb.com for updates. Before installation of this product please read important notice, disclosure and warranty conditions printed on the back of the box.

Before you start using this product please follow these basic guidelines:

1. Please carefully read the manual thoroughly before beginning with the installation process!
2. Please remove your motherboard from the computer to assure safest mounting process in order to prevent any possible damages to your CPU and/or motherboard's circuit board (PCB).
3. The EK-HFB and EK-ACF type fittings require only a small amount of force to screw them firmly in place since the liquid seal is ensured by the rubber o-ring gaskets.
4. The use of quality, market proved corrosion inhibiting coolants is always strongly recommended for any liquid cooling system.

GENERAL INFORMATION Sample photo of ASUS Strix X470 Gaming motherboard

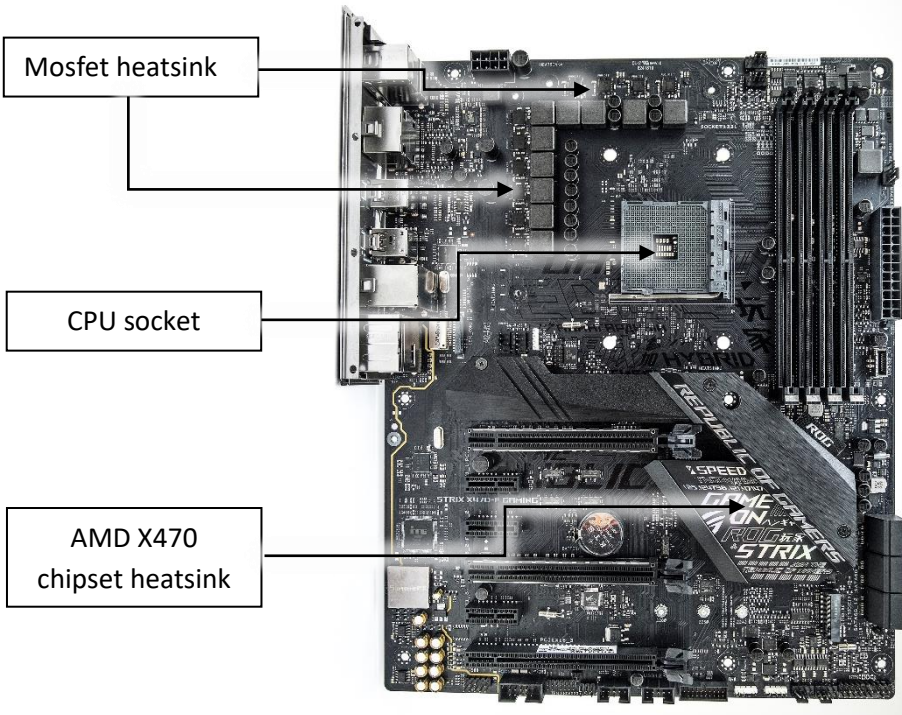

BAG CONTENT: Bag content is universal for all water blocks, you may not need all screws.

			(box intentionally left blank)
M2.5x5 AX1	M2.5 PVC washer	M2.5 adhesive	
5pcs	5pcs	5pcs	
			(box intentionally left blank)
Thermal grease	M3x10 DIN7984	2mm Allen key	
1pc	5pcs	1pc	
Replacement mounting mechanism: FB X370 MB (EAN: 3831109872376)			

STEP 1: PREPARING YOUR MOTHERBOARD

REMOVING STOCK COOLER. Remove all encircled screws. There are 4 screws on the back of the motherboard that need to be removed in order to remove the factory installed MOSFET cooling solution. Additional 2 screws need to be removed to remove the plastic I/O. Please store the removed material away for later use. You can attach the I/O cover back, after you mount the Monoblock.

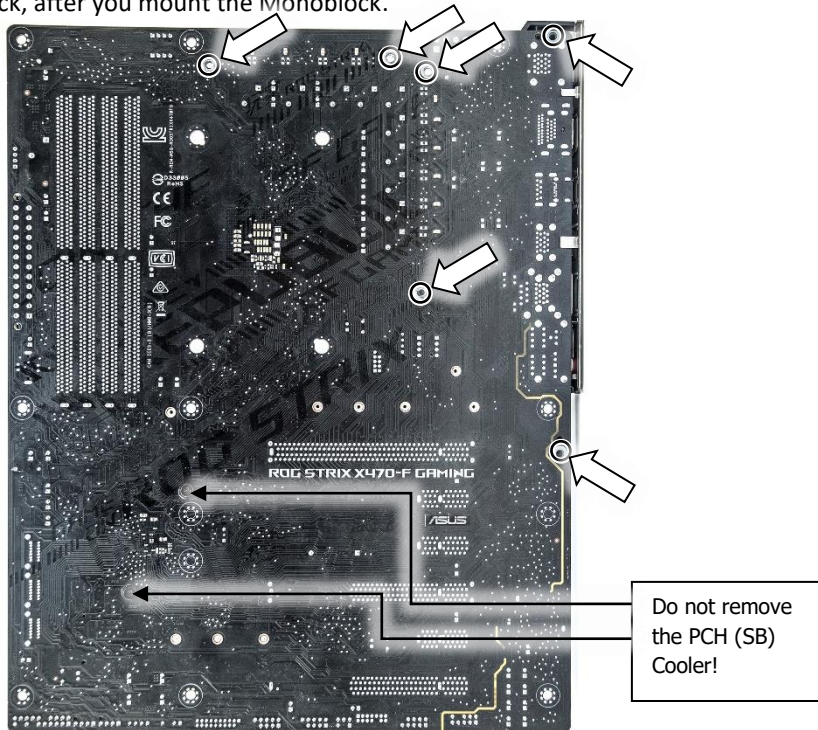

Removing of the original plastic hold-down clamps and the factory backplate: Using Philips-head screwdriver remove the four UNC 6-32 screws securing the original plastic hold-down clamps around the socket as shown on the sketch. Remove the original AMD® backplate and the hold-down clamps and store them away.

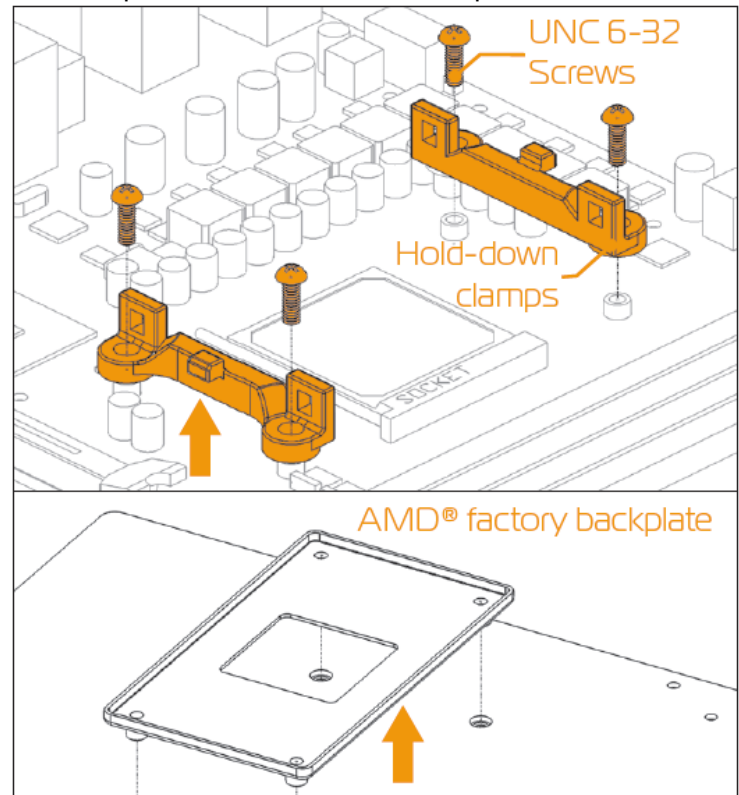

CUTTING THERMAL PADS. Your block comes with thermal pads which needs to be trimmed in order to fit the voltage regulation area (MOSFETs and coils) on the motherboard's circuit board. **WARNING: DIMENSIONS ON PICTURES BELOW ARE SCALED.**

PLACING THERMAL PADS ON MOTHERBOARD. Place thermal pads on PCB as shown on the picture
PLEASE REMOVE THE PROTECTIVE FOIL FROM BOTH SIDES OF THE THERMAL PADS PRIOR TO INSTALLATION!

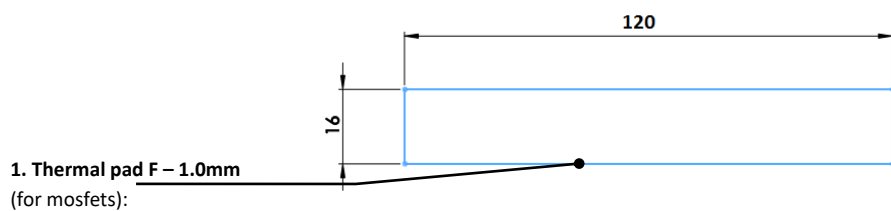

1. Thermal pad F - 1.0mm (for mosfets):

Place 1mm thermal pads (1) in larger strips over marked area and make sure all mosfet chips and coils are covered.

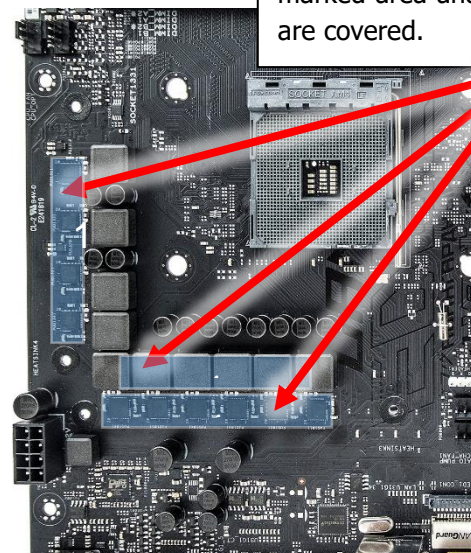

Replacement thermal pads @ EKWB web shop:
Thermal PAD F 1mm - (120x12mm) [EAN: 3830046996732]

STEP 2: PREPARING YOUR MOTHERBOARD

APPLYING THERMAL COMPOUND. Apply thermal compound on CPU heat spreader (IHS) - see sample photo on right with enclosed EK-TIM Ectotherm thermal grease.

The quantity of about two rice grains is just about right. There is no need to cover the whole IHS. Applying too much thermal grease will have negative impact on the cooling performance!



STEP 3: PLACING THE BLOCK ON TO THE MOTHERBOARD

Install four (4) M2.5 self adhesive PVC washers under marked standoffs as shown on the picture below.

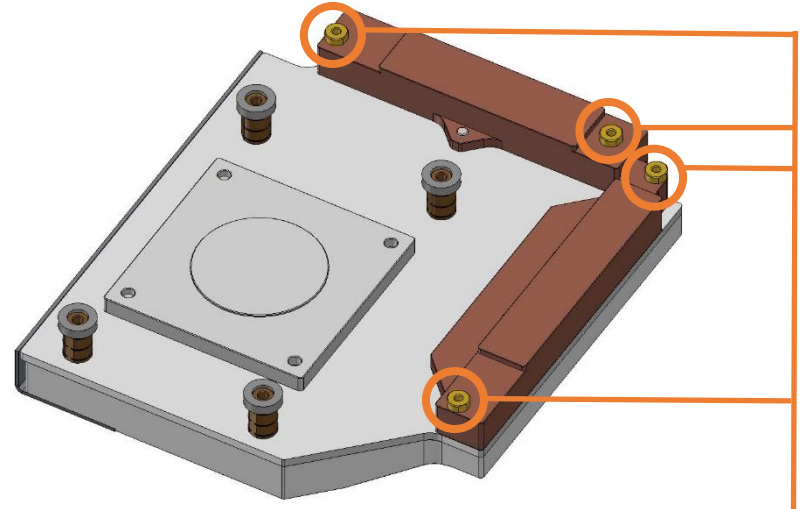

Place the M2,5 self adhesive PVC washers under marked standoffs!

PLACING THE BLOCK ON THE MOTHERBOARD. Place the EK-FB ASUS Strix X470 Gaming Monoblock series water block gently to the motherboard or vice versa (as shown on picture below). Make sure that mounting holes are aligned.

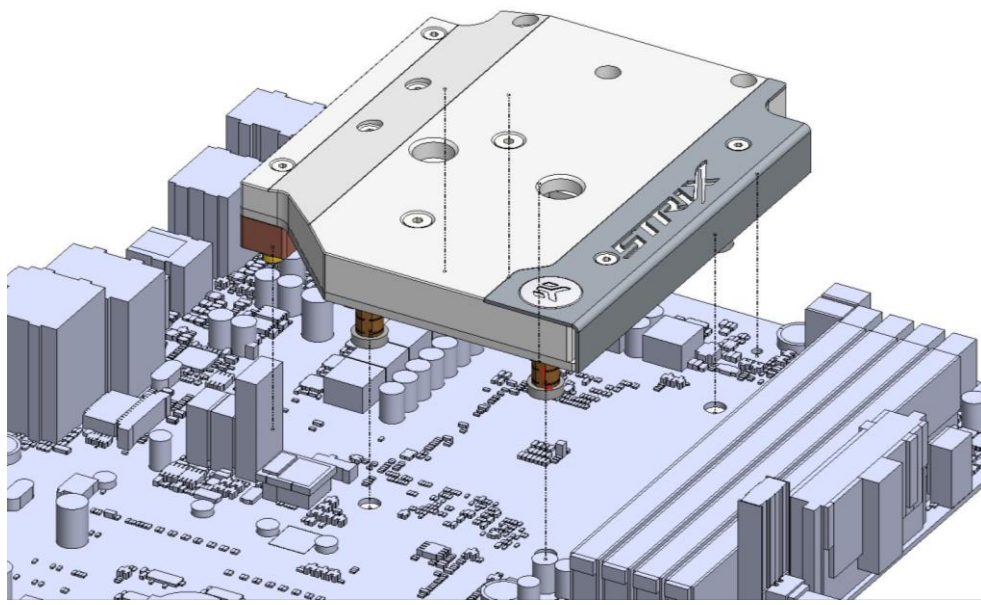

STEP 4: ATTACHING BLOCK ON TO THE MOTHERBOARD

Prior to fastening the screws please make sure the mounting holes on the motherboard's circuit board are aligned with the water block.
 A) **Mosfet part:** Use four M2,5x5 AX1 screws. Tighten the screws evenly. Do not use excessive force when tightening the screws!
 B) **CPU part:** Use four M3x10 DIN7984 screws with backplate and protective pad. Tighten the screws using enclosed 2mm allen key.

Use the enclosed screws and backplate as shown on picture below:

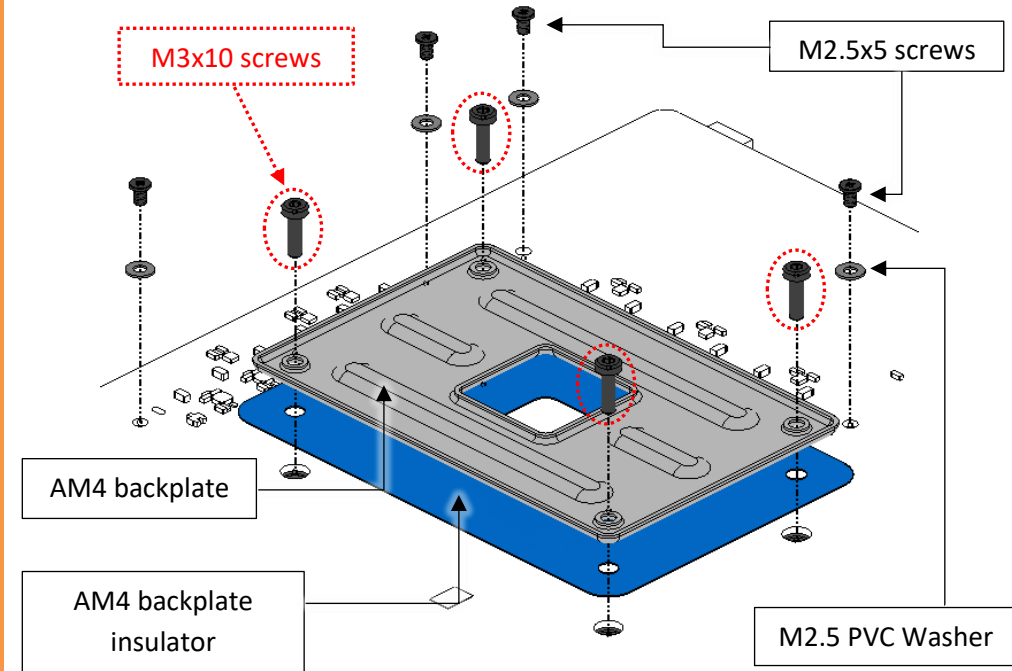

STEP 5: CONNECTING THE RGB LED STRIP (optional)

CONNECTING THE RGB LED (LED with 4 wires)

Plug the 4-pin connector from Monoblock RGB LED strip to the motherboard. Please ensure that the arrow indicated on the connector is plugged into the 12V line as indicated on your motherboard. Failure to do so will damage your motherboard or LED strip.

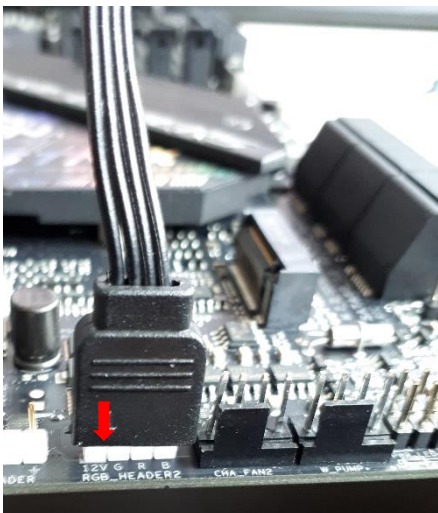

CONNECTING THE D-RGB LED (LED with 3 wires)

D-RGB LED is enclosed with your Monoblock. If you swap the LED strip, plug the 4-pin connector from Monoblock D-RGB LED strip to the ADD_HEADER on the motherboard. Please ensure that the arrow indicated on the connector is plugged into the +5V line as indicated on your motherboard. Failure to do so will damage your motherboard or LED strip

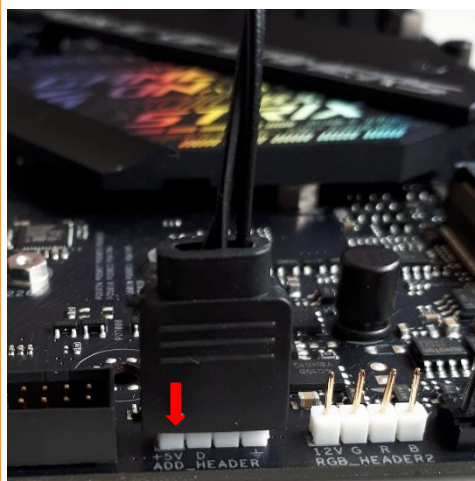

For the EK-FB ASUS Strix X470 Gaming Monoblock series water block to operate properly the G1/4 port nearest to the right edge of the water block **MUST BE USED AS THE INLET PORT**. EK recommends the use of EK-ACF fittings. When using fittings other than EK-ACF series please use hose clamps or appropriate substitute to secure the tubing to the barb. The use of biocide containing and corrosion inhibiting coolant is always recommended for any liquid cooling system.

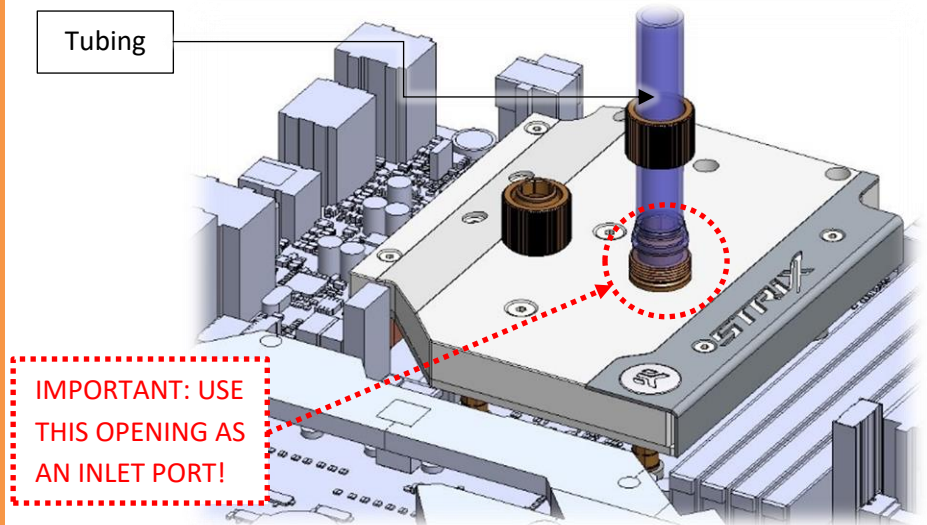

REQUIRED TOOLS AND MOUNTING SCREWS:

