

Installation and mounting manuals for EK-FC9800 GX2 water block:

This product is intended for expert users. Please consult with a qualified technician for installation. Improper installation may result in damage to your components. EK Water Blocks assumes no liability whatsoever, expressed or implied, for the use of these products, nor their installation. The following instructions are subject to change without notice. Please visit our web site at www.ekwaterblocks.com for updates.

If you need to screw in the fittings, please use small amount of force otherwise the high flow fittings might break. The fittings do not need to be tightened with high force.

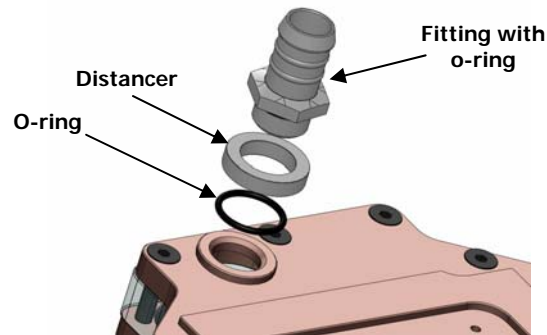

Picture 1: Fitting and plug spacer with o-ring.

Step 1. Remove the graphic card from computer.

Step 2. Remove original heat sink and remove remains of original thermal compound. So the graphic card remains clean. For help with disassembling please follow the disassembling guide in 9800 GX2 review at: http://www.techpowerup.com/reviews/Zotac/GeForce_9800_GX2 (pictures and link is published with permission of www.techpowerup.com owner)

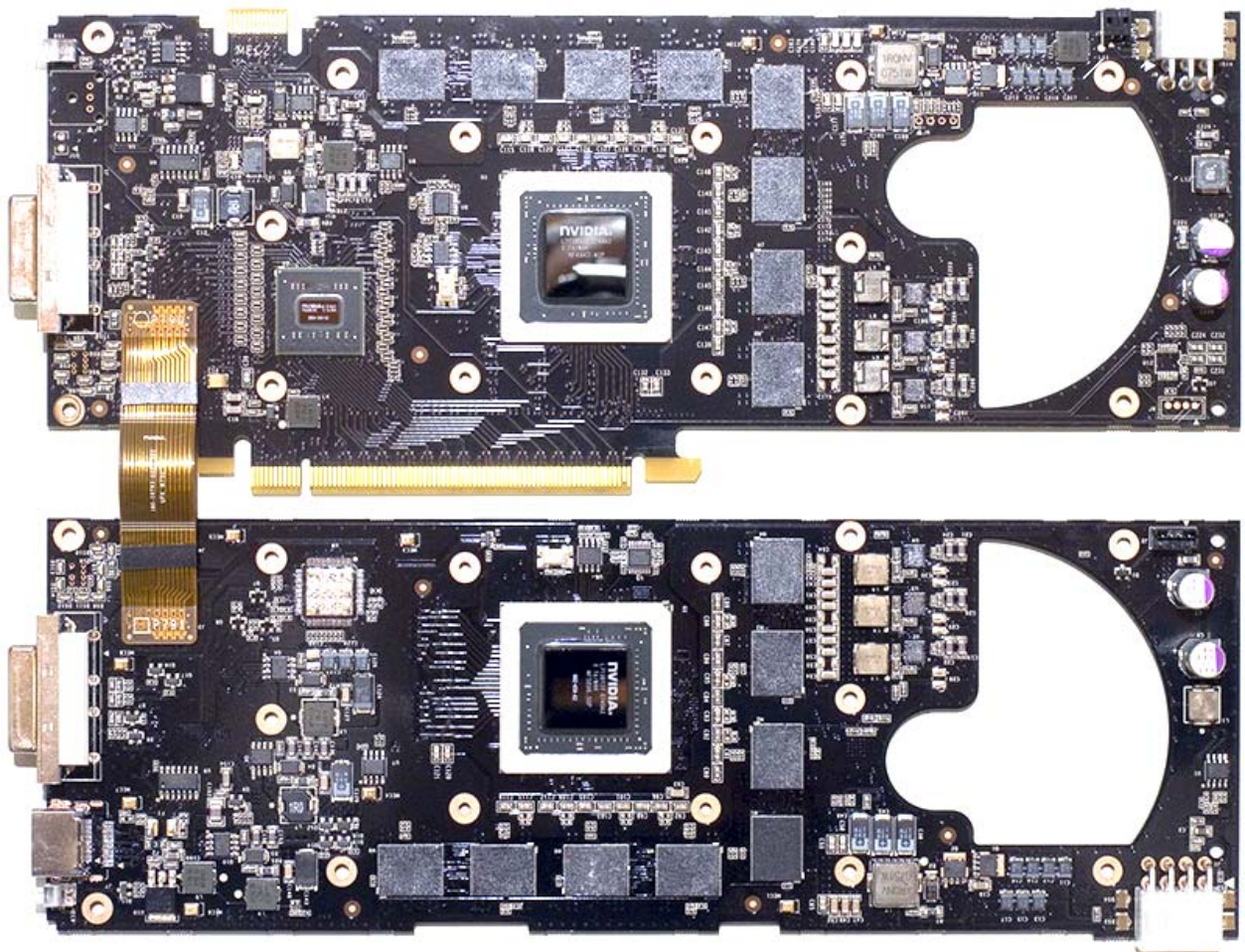

Picture 2: disassembled GeForce 9800 GX2 series graphic card without cooler.



Picture 3: Disassembling the top part 1



Picture 4: Disassembling the top part 2

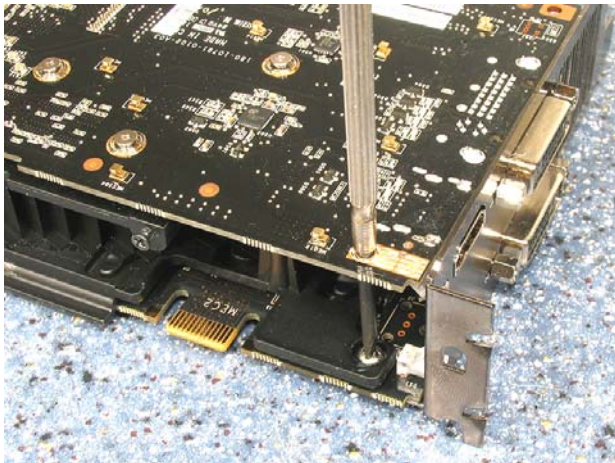

Picture 5: Disassembling

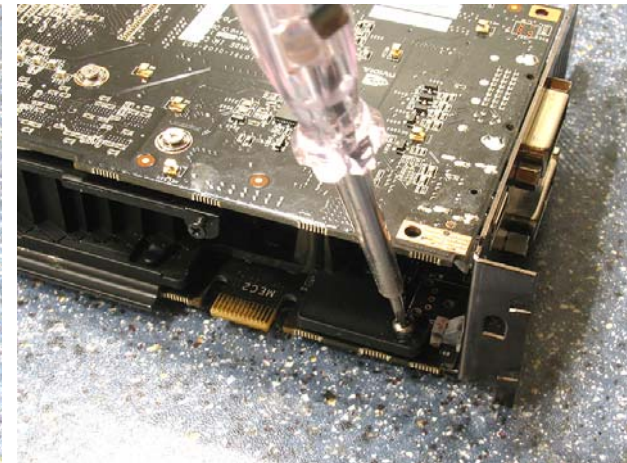

Picture 6: Disassembling

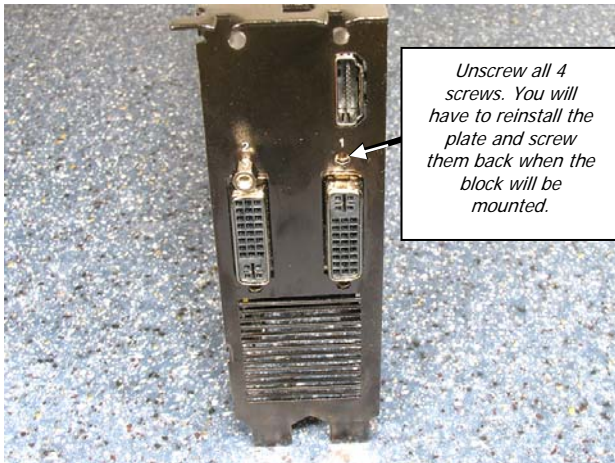

Picture 7: Disassembling the screws for VGA connectors

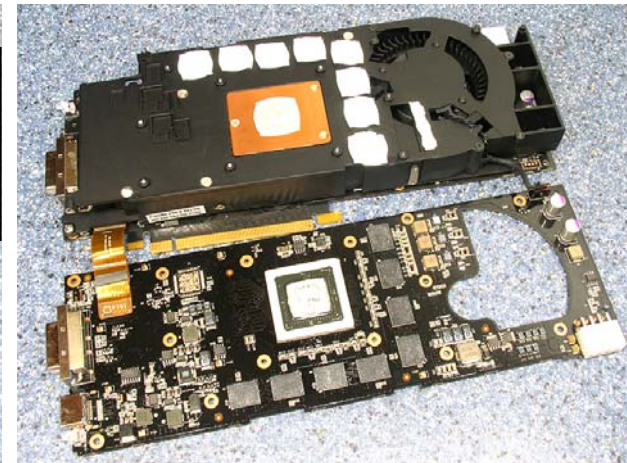

Picture 8: Disassembling



Picture 8: Disassembling - SLI bridge connection



Picture 9: Disassembling screw set (carefully store them all)

Step 3. Apply thermal compound: lightly coat the GPU, RAMs and with for example Céramique™ thermal compound. Follow this link http://www.arcticsilver.com/ceramique_instructions.htm for detailed instructions. EK Water Blocks recommends non-conductive Arctic Silver Céramique™.

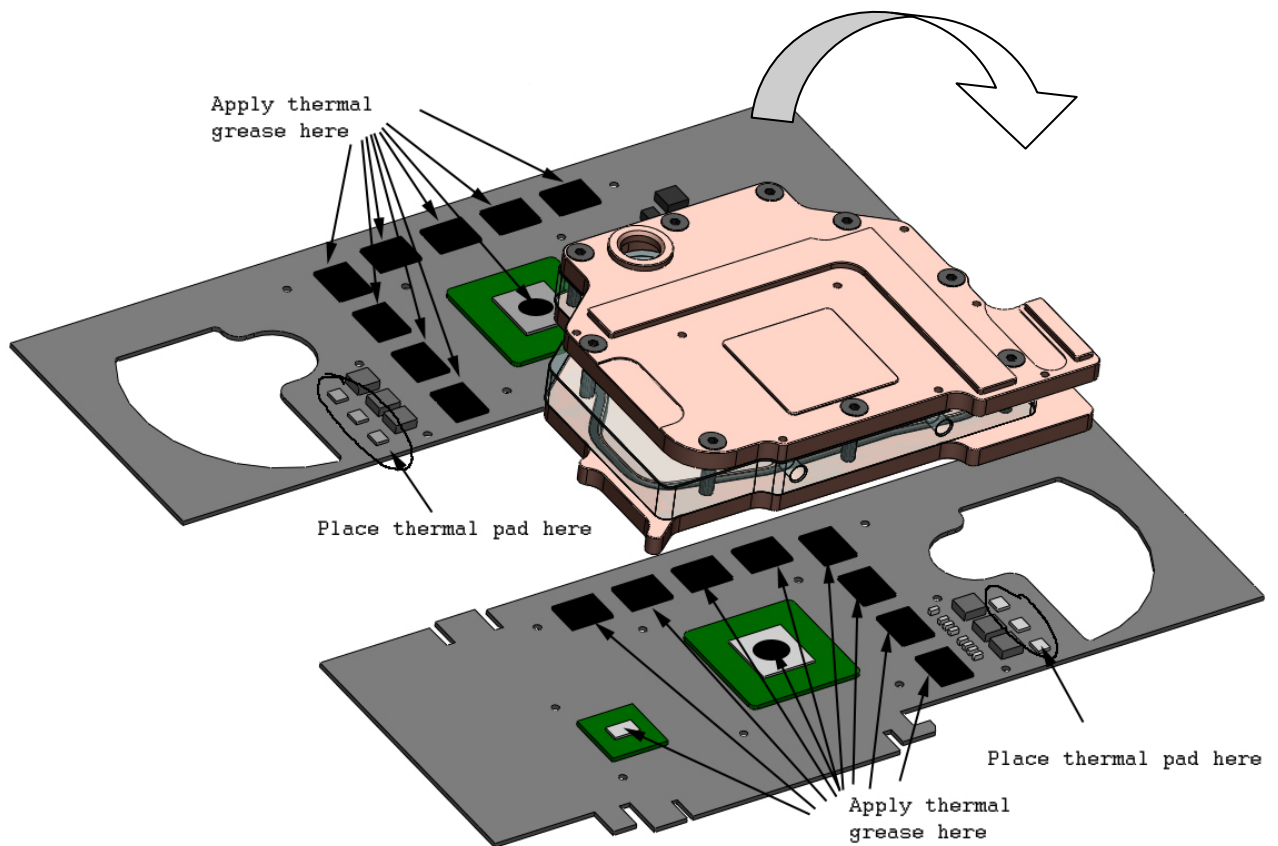

Picture 10: Applying thermal compound.

Step 4.

Place the water block on graphic card and screw the water block with enclosed screws. For perfect contact the block mounts without spring system, therefore **when installing be very cautious and tighten all screws equally**. If the screws are tightened too much the PCB of graphic card will bend too much and might get damaged.

Start tightening the screws from the GPU and continue outwards. Please use minimum pressure on encircled screws on bottom image. Because of screw position if applied too much pressure the graphic card might mend and cause bad contact with water block.

Use enclosed screws M2,5 X 8 like shown on picture below:

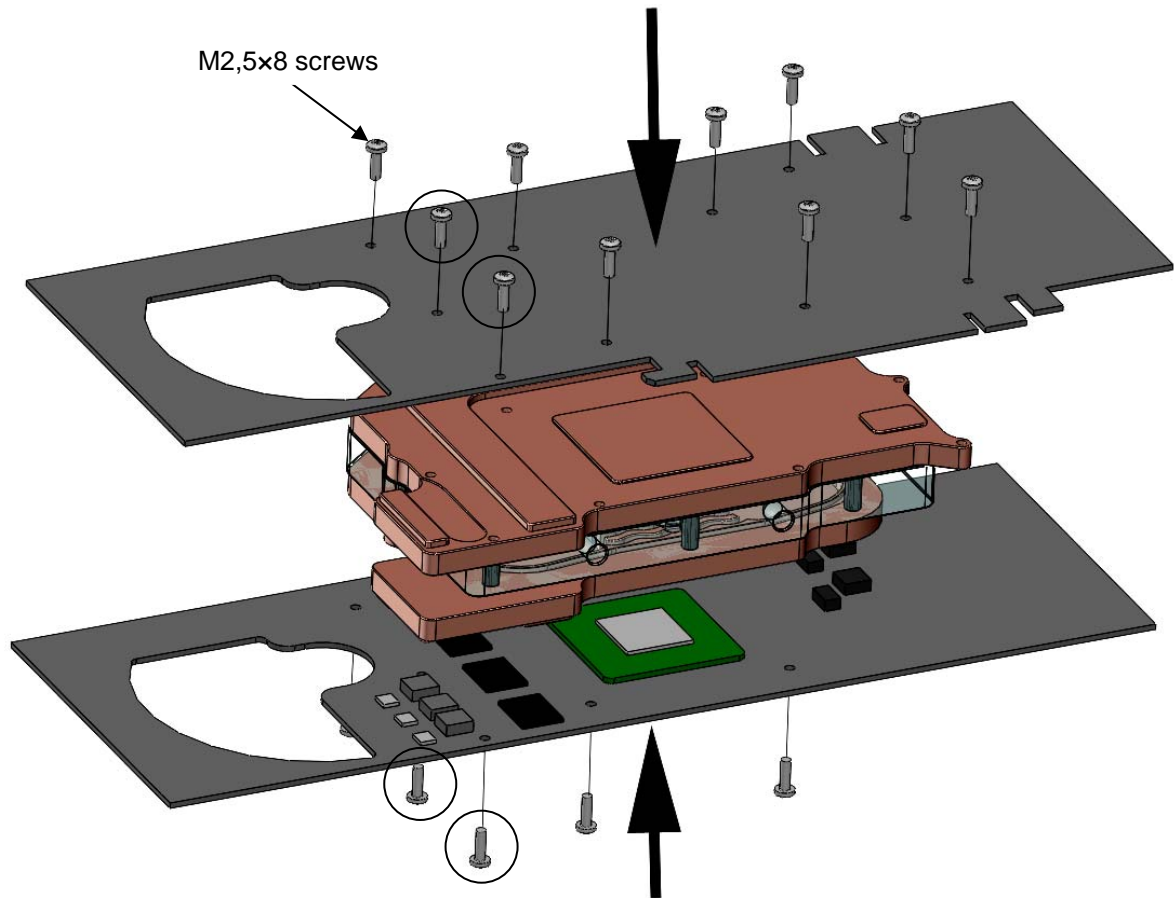

Picture 4: Mounting installation:

Step 5. Remove the block and check for contact surface. Then repeat steps 3 and 4. And apply more or less pressure on area where you have found it necessary.

Step 6. Connecting the water-block(s) to the cooling circuit and attaching the tubes:

To insecure the tubes stays properly on the fittings please use hose clamps or appropriate substitute. The use of an algacide is nonetheless recommended in any liquid cooling system.

WERY IMPORTANT NOTICE

Once the installation is completed, it is always a good idea to test the circuit for leaks, prior to powering up the computer. We recommend a 24 hour leak test prior to powering up the computer. Do not test the water block using city water pressure. This will bow the top of the housing and render the block unusable (and will void your warranty).

IMPORTANT DISCLOSURES:

While all efforts have been made to provide the most comprehensive tutorial possible, EK Water Blocks assumes no liability expressed or implied for any damage(s) occurring to your components as a result of using EK Water Blocks cooling products, either due to mistake or omission on our part in the above instructions, or due to failure or defect in the EK Water Blocks cooling products.

WARRANTY:

Our products are guaranteed for 24 months from the date of delivery to the final user against defects in materials or workmanship. During this period, they will be repaired or have parts replaced provided that: (I) the product is returned to the agent from which it was purchased; (II) the product has been purchased by the end user and not used for hire purposes; (III) the product has not been misused, handled carelessly, or other than in accordance with any instructions provided with respect to its use. This guarantee does not confer rights other than those expressly set out above and does not cover any claims for consequential loss or damage. This guarantee is offered as an extra benefit and does not affect your statutory rights as a consumer. **The guarantee is not valid if there are used aggressive UV additives.**