



Product Specification Sheet

EK-FB KIT EVGA X58

EAN / Part #: 3830046991386

Copper Plexi

Copper Acetal

Nickel Plexi

Nickel Acetal

Summary:

- Featuring a unique, modern look copper design High performance Full Board water block for EVGA X 58 series motherboards.
- EK FB series water blocks cover all chips on motherboards that require cooling if overclocked.
- An extreme high flow path design and unique increased cooling surface over Northbridge, Southbridge and Mosfets keeps all your motherboard components cool even at highest loads and over clock.
- Blocks base is made of SE CU electrolytic copper.
- High quality CNC manufacturing.
- Leak tested to 2 bar pressure (30psi).
- Safe, noob-proof mounting system with Standoffs.

Key Features:

- Real high flow internal design gives minimum flow restriction which allows lowest possible temperatures, not only at FB water block, but also in the entire water-cooling system.
- Cools NB, SB and VREGs.
- Multiple barb/fitting position allows 2 different fitting configurations. Allows maximum flexibility for water cooling system setup also in SLI, 3-SLI and Quad-SLI.
- Reduces temperatures up to 40°C or more at maximum load.
- Much cooler components allow maximum possible overclocking.

Technical data:

- dimensions of copper base NB/SB: 111 x 134 x 6mm
- dimensions of acrylic top NB/SB: 112 x 135 x 8mm
- dimensions of copper base VREG: 127 x 26 x 12mm
- dimensions of acrylic top VREG: 123x 24 x 12mm
- threads: 4 x G 1/4
- fittings: optional, not enclosed
- neto weight: 440g
- bruto weight: 500g

Packing list:

- 2 x Water block
- Mounting mechanism with 12 washers
- Thermal pads

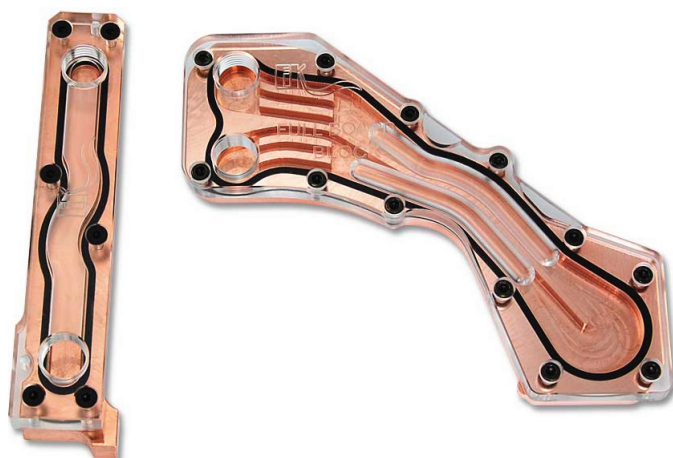

Do not forget other EK products for your water cooling system:



blocks



radiators



pumps



resevoirs



accessories

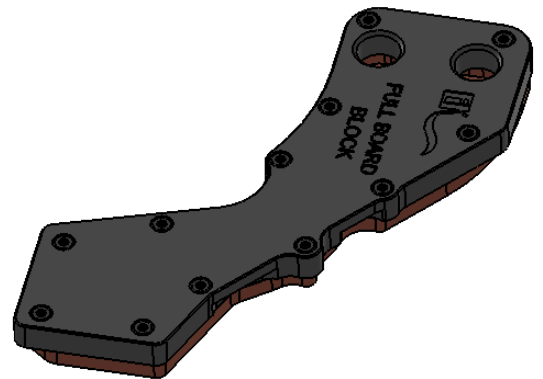
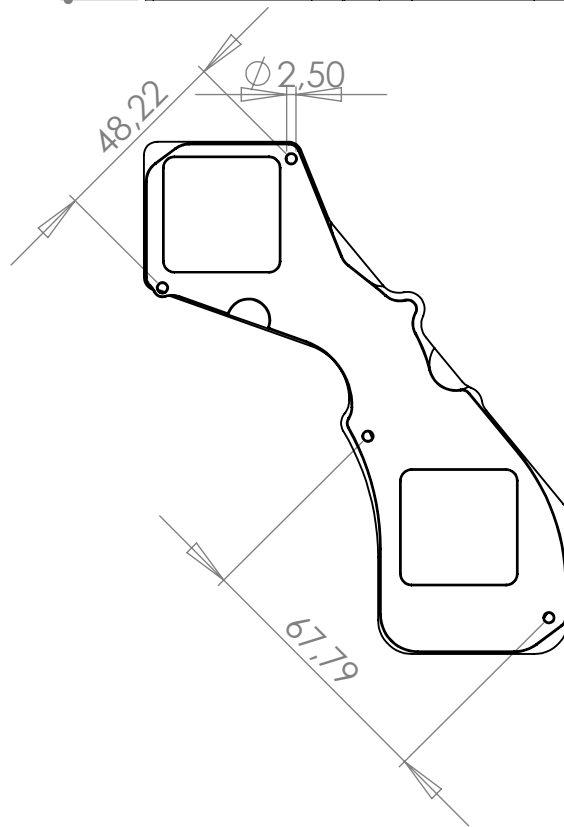
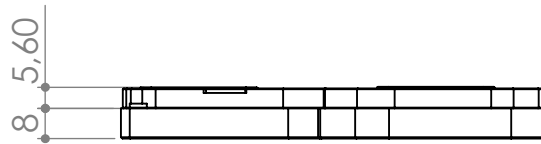
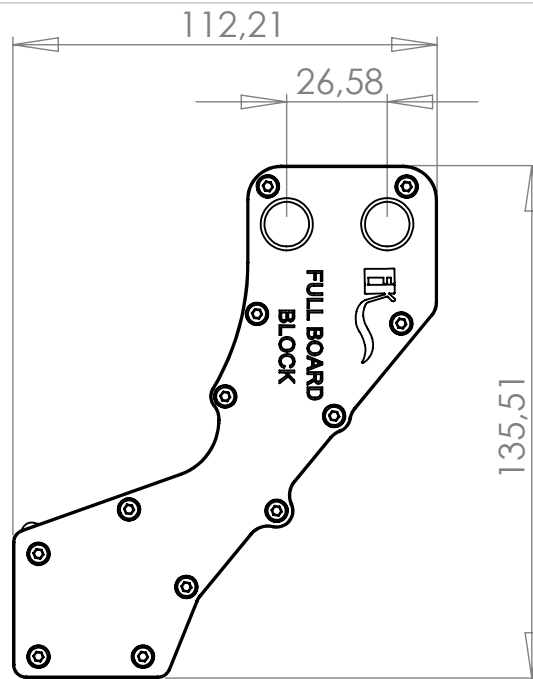

IMPORTANT DISCLOSURE: Drawing is copyrighted and property of EKWB d.o.o. company. Drawing is supplied only for easier compatibility recognition by user and can not be used for any other intention.



PRODUCT NAME: **EK-FB KIT EVGA X58**

Scale: **1:2**

Sheet format A4

Sheet 1 of 2

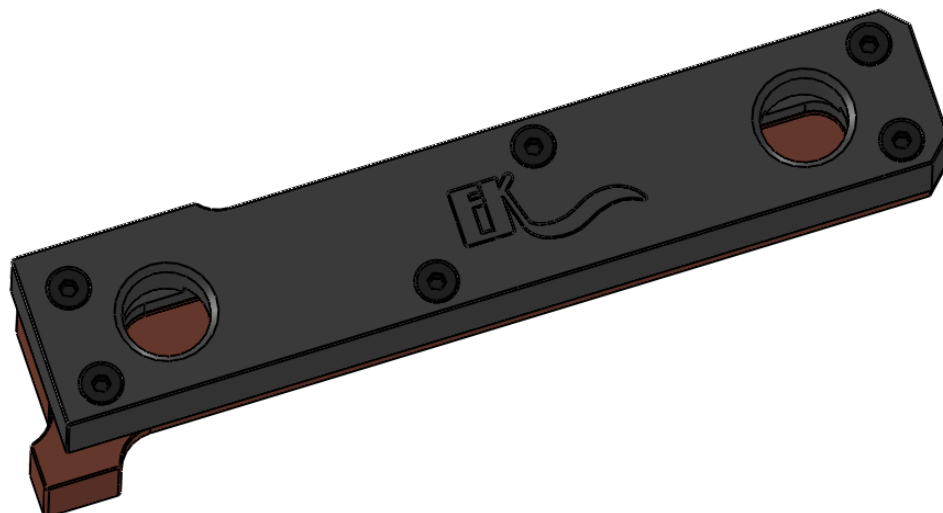
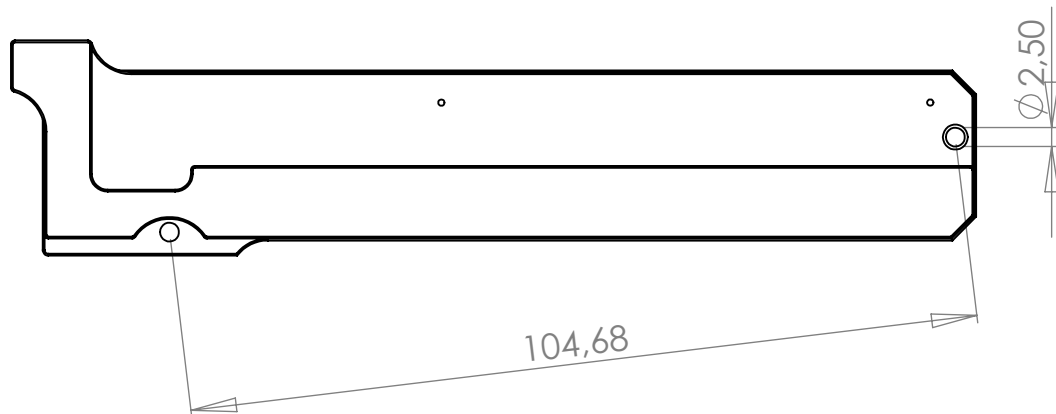
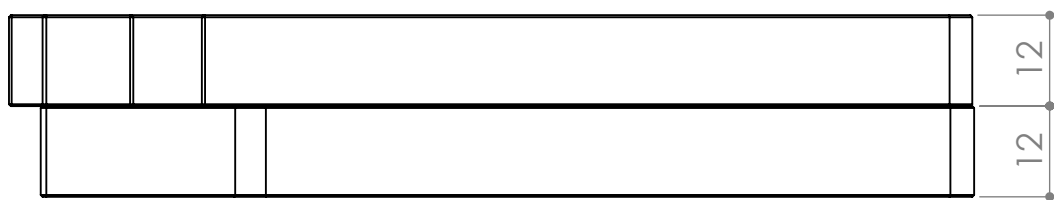
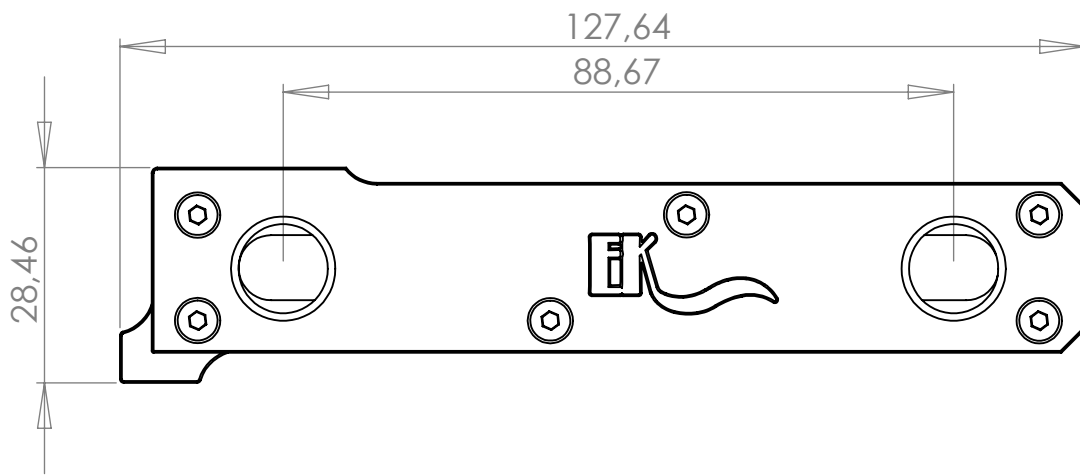

IMPORTANT DISCLOSURE: Drawing is copyrighted and property of EKWB d.o.o. company. Drawing is supplied only for easier compatibility recognition by user and can not be used for any other intention.



PRODUCT NAME: **EK-FB KIT EVGA X58**

Scale: **1:1**

Sheet format A4

Sheet 2 of 2